

KENWOOD

MULTIPLE DVD VCD CD PLAYER

DV-5900M



MULTIPLE DVD VCD CD PLAYER

DV-5050M DVF-J6050



This instruction manual is for some models. Model availability and features (functions) may differ depending on the country and sales area.

INSTRUCTION MANUAL

KENWOOD CORPORATION

0-1 Before applying power

Units are designed for operation as follows.

U.S.A. and Canada AC 120 V only

Europe and U.K. AC 230 V only

Other countries AC 110-240 V

 **Caution : Read this page carefully to ensure safe operation.**

For the United Kingdom

Factory fitted moulded mains plug

- 1.** The mains plug contains a fuse. For replacement, use only a 13-Amp ASTA-approved (BS1362) fuse.
- 2.** The fuse cover must be refitted when replacing the fuse in the moulded plug.
- 3.** Do not cut off the mains plug from this equipment. If the plug fitted is not suitable for the power points in your home or the cable is too short to reach a power point, then obtain an appropriate safety approved extension lead or adapter, or consult your dealer.

If nonetheless the mains plug is cut off, remove the fuse and dispose of the plug immediately, to avoid a possible shock hazard by inadvertent connection to the mains supply.

IMPORTANT : The wires in the mains lead are colored in accordance with the following code:





Blue : Neutral

Brown : Live

Do not connect those leads to the earth terminal of a three-pin plug.

0-2 Safety precautions

WARNING : TO PREVENT FIRE OR ELECTRIC SHOCK, DO NOT EXPOSE THIS APPLIANCE TO RAIN OR MOISTURE.

	<p>CAUTION RISK OF ELECTRIC SHOCK DO NOT OPEN</p>		<p>CAUTION: TO REDUCE THE RISK OF ELECTRIC SHOCK, DO NOT REMOVE COVER (OR BACK). NO USER-SERVICEABLE PARTS INSIDE. REFER SERVICING TO QUALIFIED SERVICE PERSONNEL.</p>
	<p>THE LIGHTNING FLASH WITH ARROWHEAD SYMBOL, WITHIN AN EQUILATERAL TRIANGLE, IS INTENDED TO ALERT THE USER TO THE PRESENCE OF UNINSULATED "DANGEROUS VOLTAGE" WITHIN THE PRODUCT'S ENCLOSURE THAT MAY BE OF SUFFICIENT MAGNITUDE TO CONSTITUTE A RISK OF ELECTRIC SHOCK TO PERSONS.</p>		
	<p>THE EXCLAMATION POINT WITHIN AN EQUILATERAL TRIANGLE IS INTENDED TO ALERT THE USER TO THE PRESENCE OF IMPORTANT OPERATING AND MAINTENANCE (SERVICING) INSTRUCTIONS IN THE LITERATURE ACCOMPANYING THE APPLIANCE.</p>		

The marking of products using lasers (For countries other than U.S.A., U.S.- Military and Canada)

**CLASS 1
LASER PRODUCT**

The marking this product has been classified as Class 1. It means that there is no danger of hazardous radiation outside the product.

Location: Back panel

CAUTION
VISIBLE LASER RADIATION
WHEN OPEN. DO NOT
STARE INTO BEAM.

Inside this laser product, a laser diode classified as Class 2 laser radiation is contained as alerted by the internal caution label shown above. Do not stare into beam.

Location: DVD laser pick-up unit cover inside this product

0-3 Unpacking

Unpack the unit carefully and make sure that all the accessories are present.

If any accessories are missing, or if the unit is damaged or fails to operate, notify your dealer immediately. If the unit was shipped to you directly, notify your shipper immediately. Kenwood recommends that you retain the original carton and packing materials in case you need to move or ship the unit in the future.

Keep this manual handy for future reference.

0-4 Accessories

Standard remote control unit (1)

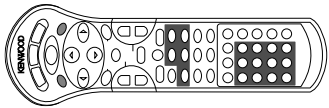

Keyboard remote control unit (1)
DV-5900M only

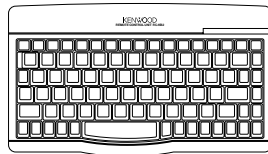

Batteries (R6/AA) (2)
(DV-5900M only)

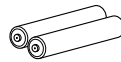

Batteries (R03/AAA) (2)

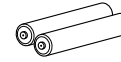

Audio cables

DV-5900M (3)
DV-5050M/DVF-J6050 (1)

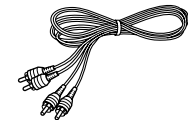

Video cable (1)

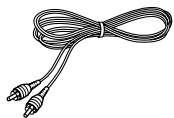

S-Video cable (1)



Coaxial cable (1)

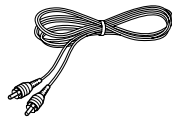

RS-232C cable (1)



System control cable (2)



For countries other than U.S.A., U.S.-Military, Canada, Europe and U.K.

AC plug adapter (1)

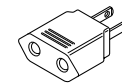

Use to adapt the plug on the power cord to the shape of the wall outlet. (Accessory only for regions where use is necessary.)

0-5 Features

Compatible with DVD AUDIO, one of the latest digital audio formats (DV-5900M only)

The DVD AUDIO reproduces 2-channel, 192 kHz, 24-bit sampled digital audio or 6-channel, 96 kHz, 24-bit sampled audio. This innovative technology has made possible audio reproduction in unprecedented high quality. Picture information and character information (ALBUM TEXT) are also provided.

Versatile DVD VIDEO Functions

The DVD VIDEO provides horizontal resolution of 430 lines, which exceeds that of DVD or S VHS video (400 lines) or laserdisc (430 lines).

Multi-audio function: With DVD discs marked with the  icon, the desired language can be played back by selecting it from up to 8 languages. (The number of available languages is variable depending on the discs.)

Multi-subtitle function: With DVD discs marked with the  icon, the subtitle language can be selected from up to 32 languages. (The number of subtitle languages is variable depending on the discs.)

Angle function: With DVD discs marked with the  icon, a single object can be viewed in up to 9 angles by switching. (The number of available angles is variable depending on the discs.)

Compatibility with Wide Range of Digital Surround Software

The unit incorporates Dolby Digital decoder, DTS decoder, MPEG multi-channel decoder and Packed PCM decoder so that the users can enjoy the sound of real cinemas. The unit can also be connected to the user's existing TV set

6-Channel Output Terminals (DV-5900M only)

These output terminals can be connected to an amplifier with 6-channel input compatibility to enjoy high-bit, high-sampling rate multi-channel sound.

DVD player with CD-R and CD-RW disc compatibility

This DVD player can play back tracks recorded in CD-R (Compact Disc Recordable) and CD-RW (Compact Disc Rewritable) as well as those in music CD.

* Only finalized discs can be played back.

MP3 file playback capabilities

This DVD player can also play back the MP3 files which are the latest formats for storage of music data.

400-Disc mega changer

The DVD mega changer accommodates 400 plus 3 discs, the largest number in the industry.

Daisy chain connection

Up to three units can be played, making it possible to play up to 1200 discs continuously.

Progressive scanning (NTSC area only)

The video projection method can be switched between "Interlaced" and "Progressive" scanning according to the area in which this unit is used.

Two-side playback

Double-sided DVD disc can be played back without the troublesome disc return operation. The played side of disc can simply be switched with a one-touch operation (DISC FLIP).

Title input facility

Character information such as the disc and track titles can be input on this unit.

Keyboard remote control unit (DV-5900M only)

This facilitates the title input operations.

PLUS1 - PLUS3 slots

The discs in these slots can be played or ejected with one-touch operation, without the need of designating the disc number. In addition, these slots are provided with wider areas around the grooves to facilitate insertion and ejection of discs.



DVD control function (Except for Asia)

The basic operations of this unit, such as playback and stop, can be remote controlled from the LCD remote control unit provided with a KENWOOD AV receiver.

This instruction manual is for some models. Model availability and features (functions) may differ depending on the country and sales area.

0-6 Contents

Caution : Read the pages marked  carefully to ensure safe operation.

	0-1 Before applying power	2
	0-2 Safety precautions	2
	0-3 Unpacking	3
	0-4 Accessories	3
	0-5 Features	4
	0-6 Contents	5
	0-7 Systems and Types of Playable Discs	7
	0-7-1 Media that can be played back with this equipment (CD-R, CD-RW)	7
	0-7-2 Playback of CD-R and CD-RW discs	7
	0-8 Unplayable Discs	7
	0-9 Icons Inscribed on DVD Discs	8
	0-10 Region Codes of This Player	8
	0-11 Region codes of the DVD VIDEO discs that can be played with this player	9
	0-12 Video Formats	9
	0-12-1 TV formats in major countries	9
	0-12-2 Checking the Video Format	9
	0-12-3 When the video formats are different	9
	0-13 MP3 File That Can Be Played Back with This Equipment	10

Chapter 1: Connection of Equipment

1-1 Introduction	11
1-2 Preparation of Standard Remote Control Unit	12
1-3 Preparation of Keyboard Remote Control Unit	12
1-4 STANDBY mode	12
1-5 Connection of Video Outputs	13
1-5-1 To Setup of the Player	13
1-5-2 Connection	13

1-6 Connection of Audio Output	15
1-6-1 2-channel stereo connection	15
1-6-2 6 channel (5.1 ch) audio connection	16
1-6-3 Digital output connection	16
1-7 Daisy Chain Connection	18
1-7-1 Setup	18
1-7-2 Connection of Video Output Terminals	18
1-7-3 Connection of Audio Output Terminals	19
1-8 PC Link Connection	20
1-9 DVD Control Function	20

Chapter 2: Controls and indicators

2-1 Introduction	21
2-2 Front Panel	22
2-3 Display	23
2-3-1 Switching the Display Brightness	23
2-4 Standard Remote Control Unit	24
2-5 Keyboard Remote Control Unit	26

Chapter 3: Basic Operation

3-1 Introduction	27
3-2 Configuration of Discs	28
3-3 Turning power on	28
3-4 Inserting discs	29
3-5 In regard to ALL DATA READ mode	29
3-6 Operation restriction according to the disc or player status	30
3-7 Playing discs	30
3-8 PLUS1 to PLUS3 slots	30
3-9 Playing discs by changing them	30
3-10 Playing from the selected disc	30

3-11 Playing discs by selecting the title, chapter, track or file	31
3-12 Skipping a track, chapter or file	31
3-13 Stopping playback	31
3-14 Still picture display and playback pause	31
3-15 Frame-by-frame advance	31
3-16 Forward search and reverse search	32
3-17 Slow playback and reverse slow playback	32
3-18 What is the "normal play TRACK mode"?	32
3-19 Menu playback of DVD	33
3-20 Menu playback of P.B.C.-compatible VCD	33
3-20-1 Hierarchical structure of VCD menus	33
3-20-2 Main control buttons used in VCD playback, and examples of indications	33
3-20-3 Switching P.B.C. On and Off	33
3-21 Switching still pictures of DVD AUDIO	34
3-22 Switching the sequential play mode	34
3-23 Repeat playback	34
3-23-1 OSD icons that can be selected with each disc type and mode	35
3-24 Switching the time display	36
3-25 Pure Audio function	36
3-26 Switching the audio language	36

Chapter 4: OSD Operation

4-1 Introduction	37
4-2 Basic OSD Operation	38
4-3 "MAIN" OSD Operation	39
4-3-1 Selecting the disc to be played	39
4-3-2 Selecting a group, title, folder, chapter, track or file	39
4-3-3 Time display switching and time search	40

0-6 Contents

Caution : Read the pages marked  carefully to ensure safe operation.

4-3-4	Memory playback	40
4-3-5	Repeat playback	41
4-3-6	A-B repeat playback	42
4-4	"SOUND" OSD Operation	43
4-4-1	Switching the audio language	43
4-4-2	Virtual Surround function	43
4-4-3	Cinema Voice function	44
4-4-4	Down Mix function	44
4-5	"VISUAL" OSD Operation	45
4-5-1	Switching the subtitle language	45
4-5-2	Adjusting the picture quality	45
4-5-3	Switching the viewing angle	47

Chapter 5: Applied Operations

5-1	Introduction	48
5-2	Switching the Play Modes	49
5-3	Program Playback	49
5-3-1	Registering and playing the program	49
5-3-2	Checking the program	50
5-3-3	To change a track in the program	50
5-3-4	Clearing the program	50
5-4	Random playback	50
5-4-1	Stopping random playback	50
5-5	TEXT DISC Operation	51
5-5-1	Switching the character information	51
5-6	Daisy chain function	52
5-6-1	Turning power on	52
5-6-2	Features available with daisy chain connection	52
5-6-3	Operation procedure	52
5-7	Switching the "DVD Video Mode"	53
5-8	Playback of Double-Sided DVD	53
5-9	Bonus Group	53

Chapter 6: Specifying and Using Disc or Track Data

6-1	Introduction	54
6-1-1	The DVD mega-changer can	55
6-1-2	Steps of MODE button operation	55
6-2	Listening to music by genre	56
6-2-1	Registration of music type	56
6-2-2	Playing the music type	56
6-2-3	To clear the music type	57
6-3	Reorganizing discs to desired groups	57
6-3-1	Registration of user file	57
6-3-2	Playing the user file	58
6-3-3	To clear the user file	58
6-3-4	To initialize the user file	58
6-3-5	Assigning user file names	59
6-4	Registration of Title	61
6-4-1	Assigning Title	61
6-5	Disc search	64
6-5-1	Disc search using the remote control unit	64
6-5-2	Disc search using the OSD	66
6-6	Searching a desired folder/file by its title	70

Chapter 7: Various Setups

7-1	Introduction	71
7-2	Basic Operations in Setup Screen	72
7-3	"MAIN" Setting	73
7-3-1	When "MAIN" is selected in "SET UP MENU"	73
7-3-2	"Rating" Setting	75
7-3-3	Input of Password	75
7-4	"SOUND" Setting	76
7-4-1	When "SOUND" is selected in "SET UP MENU"	76
7-4-2	"Speaker Setting"	78
7-4-3	Delay Time Setting	81

7-5	"VISUAL" Setting	82
7-5-1	When "VISUAL" is selected in "SET UP MENU"	82
7-5-2	Disc Language Code Table	85

Chapter 8: Other Information

8-1	Malfunction of Microcomputer	86
8-2	To Be Noted	87
8-3	Troubleshooting	89
8-4	Glossary	91
8-5	Specifications	94

0-7 Systems and Types of Playable Discs

	DV-5900M	Other
DVD AUDIO 	Yes	-
DVD VIDEO 	Yes	Yes
VCD 	Yes	Yes
CD 	Yes	Yes

0-7-1 Media that can be played back with this equipment (CD-R, CD-RW)

Usable media apart from audio CDs (CD-DA)

Usable media : CD-ROM, CD-R, CD-RW

Usable formats : ISO9660 level 1 (excluding expanded formats)

Representative disc formats

Optical Disc Format	Playback on This Unit	Applicable Disc Types
CD-DA	Yes	Music CD, etc.
CD-ROM MODE 1	Yes	CD-ROM (Yellow book), etc.
CD-ROM MODE 2	No	CD-I, etc.
CD-ROM XA MODE 2 Form 1	Yes	Video CD, etc.
CD-ROM XA MODE 2 Form 2	No	Photo CD, etc.

0-7-2 Playback of CD-R and CD-RW discs

The playback of these discs may be restricted depending on the status of data written in the discs. Certain CD-R and CD-RW discs may be unable to be played back on this unit even when they have been written according to the above condition as described below.

- This unit cannot play back a disc written with packet writing.
- This unit can play back the discs written with the following writing methods:

Disc At Once

Track At Once



Session At Once

- This unit can play back only the closed sessions.
- This unit can play back only the finalized discs.

0-8 Unplayable Discs

Never attempt to play a 8 cm disc on this unit. Otherwise, the disc data may be destroyed.

Other discs which cannot be played on this unit:

- Photo CD, SACD, DVD-ROM, DVD-R/RAM, DVD-RW, VSD, CDV*, CD-G*, CD-EG*, CD-EXTRA*, etc.
* Only the audio part can be reproduced.
- A DVD VIDEO disc with a region code which does not match this unit or without a region code. For details, see "**Region Codes of This Player**". → 
- When the video format of a disc differs from that of the TV in use, the disc cannot be played normally. For details, see "**Video Formats**". → 

0-9 Icons Inscribed on DVD Discs



Indicates the playable region code.



Indicates the number of languages in the audio. The figure in the icon shows the number (max. 8 languages).



Indicates the number of available subtitle languages. The figure in the icon shows the number (max. 32 subtitle languages).



Indicates the number of viewing angles which can be viewed with the angle function. The figure in the icon shows the number (max. 9 angles).

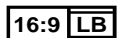

Indicates the number of available aspect ratios. LB stands for Letter Box and PS stands for Pan & Scan. (The example shown means that the 16:9 video can be converted into letterbox.)

0-10 Region Codes of This Player (DVD VIDEO disc only)

A region code defined for each country or area is assigned for each DVD VIDEO player, so it cannot play a DVD VIDEO disc if its region code do not match that of this unit. Also, a disc which does not contain any region code may sometimes be unable to be played on the player.

When purchasing a DVD VIDEO disc, make sure that it has a region code which can be played on your player.

Region Code of Player :

Usable Country or Area : Canada, United States, American Samoa, Bermuda, Johnston Island, Midway Islands, Puerto Rico, St. Pierre and Miquelon, United States Virgin, Wake Island

Region Code of Player :

Usable Country or Area : Albania, Andorra, Austria, Bahrain, Belgium, Bosnia and Herzegovina, Bulgaria, Croatia, Cyprus, Czech, Denmark, Egypt, Finland, France, Germany, Greece, Hungary, Iceland, Iran, Iraq, Ireland, Israel, Italy, Japan, Jordan, Kuwait, Lebanon, Lesotho, Liechtenstein, Luxembourg, Macedonia, Malta, Monaco, Netherlands, Norway, Oman, Poland, Portugal, Qatar, Romania, San Marino, Saudi Arabia, Slovakia, Slovenia, South Africa, Spain, Swaziland, Sweden, Switzerland, Syrian Arab Republic, Turkey, United Arab Emirates, United Kingdom, Vatican City State, Yemen, Yugoslavia, Channel Islands, Faeroe Islands, Gibraltar, Greenland, Isle of Man, Svalbard and Jan Mayen Islands

Region Code of Player :

Usable Country or Area : Brunei Darussalam, Cambodia, Indonesia, Korea, Laos, Malaysia, Myanmar, Philippines, Singapore, Thailand, Viet Nam, East Timor, Hong Kong, Macau, Taiwan

Region Code of Player :

Usable Country or Area : Antigua and Barbuda, Argentina, Australia, Bahamas, Barbados, Belize, Bolivia, Brazil, Chile, Colombia, Costa Rica, Cuba, Dominica, Dominican Republic, Ecuador, El Salvador, Fiji, Grenada, Guatemala, Guyana, Haiti, Honduras, Jamaica, Kiribati, Marshall Islands, Mexico, Micronesia, Nauru, New Zealand, Nicaragua, Palau, Panama, Papua New Guinea, Paraguay, Peru, Saint Christopher and Nevis, Saint Lucia, Saint Vincent and the Grenadines, Samoa, Solomon Islands, Suriname, Tonga, Trinidad and Tobago, Tuvalu, Uruguay, Vanuatu, Venezuela, Anguilla, British Virgin Islands, Cayman Islands, Christmas Island, Cocos Islands, Cook Islands, Falkland Islands, French Guiana, French Polynesia, Guadeloupe, Guam, Martinique, Montserrat, Netherlands Antilles, New Caledonia, Niue, Norfolk Island, Northern Mariana Islands, Pitcairn, Tokelau, Turks and Caicos Islands, Wallis and Futuna Islands

Region Code of Player :

Usable Country or Area : Afghanistan, Algeria, Angola, Armenia, Azerbaijan, Bangladesh, Belarus, Benin, Bhutan, Botswana, Burkina Faso, Burundi, Cameroon, Cape Verde, Central Africa, Chad, Comoros, Congo, Cote d'Ivoire, Djibouti,

Equatorial Guinea, Eritrea, Estonia, Ethiopia, Gabon, Gambia, Georgia, Ghana, Guinea, Guinea-Bissau, India, Kazakhstan, Kenya, Kyrgyz Republic, Latvia, Liberia, Libya, Lithuania, Madagascar, Malawi, Maldives, Mali, Mauritania, Mauritius, Moldova, Mongolia, Morocco, Mozambique, Namibia, Nepal, Niger, Nigeria, North Korea, Pakistan, Russia, Rwanda, Sao Tome and Principe, Senegal, Seychelles, Sierra Leone, Somalia, Sri Lanka, Sudan, Tadjikistan, Tanzania, Togo, Tunisia, Turkmenistan, Uganda, Ukraine, Uzbekistan, Zaire, Zambia, Zimbabwe, British Indian Territory, Jammu and Kashmir, Mayotte, Reunion, St. Helena ex. dep., Western Sahara

Region Code of Player : **6**

Usable Country or Area : China, Caicos Islands, Wallis and Futuna Islands

Region Code of Player : **8**

Professional use disc (Air Line cabin service)

0-11 Region codes of the DVD VIDEO discs that can be played with this player

This player can play back a DVD VIDEO disc which carries the corresponding code to the region code of the player shown in the table above, a marking containing the region code of the player or the "ALL" marking shown below. Even when a DVD VIDEO disc does not carry any indication of the region code, it may sometimes be unable to be played on this player due to certain restrictions.



0-12 Video Formats

The TV picture display and disc signal systems can be divided roughly into two TV formats (NTSC and PAL). They are variable depending on countries and areas.

This unit reproduces NTSC discs in NTSC format and PAL discs in PAL format. If the video formats of the disc and TV do not match, the disc cannot be reproduced correctly. It is therefore required to select the disc according to the TV set in use (country and area).

0-12-1 TV formats in major countries

NTSC : Japan, Taiwan, Korea, USA, Canada, Mexico, Philippines, Chile, etc.

PAL : China, U.K., Germany, Australia, New Zealand, Kuwait, Singapore, etc.

0-12-2 Checking the Video Format

Check the video format of the VCD and DVD discs to be played on the player as described below.

1. Check if the video formats of the TV to be used and disc to be played match each other.
 - For details, refer to the instructions provided with the TV and disc.
2. When the TV is switchable between NTSC and PAL, set the TV format according to the disc format.

TV Format	Playable Disc Format
NTSC only	NTSC
PAL only	PAL
NTSC/PAL switchable	NTSC/PAL

- Correct video cannot be reproduced if the video formats of the TV and disc do not match.

0-12-3 When the video formats are different

Try playing the disc. If the video formats of the disc and TV do not match, the played video may be black and white or become as shown below.

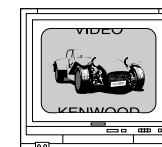

Top and bottom edges are not displayed.

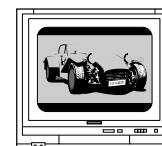

Top and bottom areas are dark.

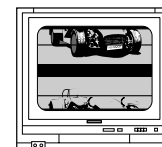

Picture turbulence due to sync unmatching.

0-13 MP3 Files That Can Be Played Back with This Equipment

Compressing MP3 files

Please set up the transfer bit rate setting for the compression software when compressing MP3 files as follows:

MP3 file

128kbps recommended (32 kbps-320 kbps)

- This unit is compatible with 32kHz, 44.1kHz (recommended) and 48 kHz sampling frequencies.

Categorizing folders

As MP3 files are compressed into high-quality sound files at an extremely high rate of compression, it is possible to record several times more tracks than audio CDs onto a single medium. It is therefore convenient to split the tracks into different folders by genre, artist or album for retrieval and repeat playback purposes.

- A maximum of 999 folders or a maximum of 999 files can be stored on a single media.
- There are cases where it is not possible to save folders in the desired sequence depending on the software being used.

Additional information

Usable formats :

ISO9660 level 1 (excluding expanded formats)

Text display

Both file and folder names are displayed in up to 8 uppercase alphanumeric characters.

Time display

With MP3 files, only the "Single Time" information is displayed.

ID3-TAG information

This unit is not compatible with this function.

"Digital" output from MP3 files

This unit does not output the "Digital" signal when it plays back an MP3 file.

Restriction by session

This unit can play back only the closed sessions.

With CD-DA

With a multi-session disc, this unit plays back the first session only.

With MP3 files

Note on the multi-session disc and CD-DA (music data)

- This unit is compatible with multi-session discs.
- The music CD data (CD-DA data) can be played only when its first session is composed of music CD data (CD-DA data).
The second and later sessions are not played back.

However, when "the number of sessions is '2'" and "its second session is composed of music CD data (CD-DA data)", the music CD data (CD-DA) can be played back.

Never add the MP3 extension logs to any files other than MP3 files. If the MP3 extension logs are added to any files other than MP3 files, the equipment will assume that they can be played back, and this will produce loud noises in the speakers, resulting in damage of adverse effects.

Check to ascertain that MP3 files can be played back correctly on the personal computer in use prior to saving them onto the media. Check to ensure that the saved file can be played back normally.

- It is not possible to confirm that files can be played back correctly while they are being saved onto the media.

Ensure that the session is closed or finalized when data has been written on media. There are cases where media on which the session has not been closed or finalized will not be played back correctly with this equipment.

- There are cases where the folder names and file names will not be displayed correctly depending on the software used to save them.
- There are cases where playback is not possible when MP3 files (CD-ROM) and music CD information (CD-DA) are saved on the same media.
- When a disc contains a mixture of different formats such as the CD-DA and MP3, the data in the CD-DA format will be played in priority.

Chapter 1: Connection of Equipment

1-1 Introduction

This manual describes the standard, most typical connections of the player. When an associated system component is connected, also refer to their instruction manuals.

For details on the connection of the following components, see the indicated reference pages.

Preparation of Standard Remote Control Unit	→ 12
Preparation of Keyboard Remote Control Unit	→ 12
STANDBY mode	→ 12
Connection of Video Outputs	→ 13
Connection of Audio Output	→ 15
Daisy Chain Connection	→ 18
PC Link Connection	→ 20
DVD Control Function	→ 20

Before Start

Do not install the player in a place where the remote control sensor is subjected to direct sunlight or the light of a fluorescent lamp base on high-frequency lighting (inverter system, etc.). Otherwise, the control range of the standard remote will be reduced.

Do not insert the power cord plugs of the player and the connected components until all of the components have been connected.

Be sure to insert all connection cables securely. If a cable is plugged incompletely, lack of video, lack of audio or noise may result.

Before connecting or disconnecting a connection cord, be sure to unplug the power plug from the wall power outlet. If a connection cable is connected or disconnected while the power plug is left connected, malfunction or equipment damage may result.

CAUTION

Be sure to adhere to the following, or proper ventilation will be blocked causing damage or fire hazard.

- Do not place any objects impairing heat radiation onto the top of the unit.
- Leave some space around the unit (from the largest outside dimension including projection) equal to or greater than, shown below.

Top panel : 10 cm

Side panel : 10 cm

Back panel : 10 cm

1-2 Preparation of Standard Remote Control Unit

Installing the batteries:

Open the cover and insert the batteries (R03/AAA) by observing the polarity marking.

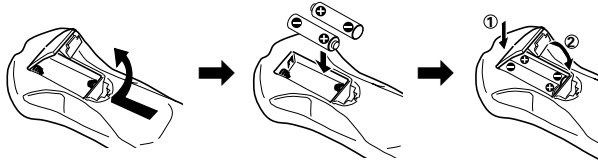

Remote control range:

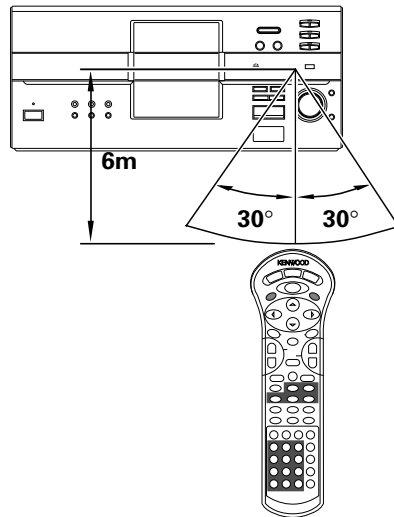

- When the controllable distance of the standard remote reduces, replace both batteries with new ones.

1-3 Preparation of Keyboard Remote Control Unit (DV-5900M only)

Installing the batteries:

Open the cover and insert the batteries (R6/AA) by observing the polarity marking.

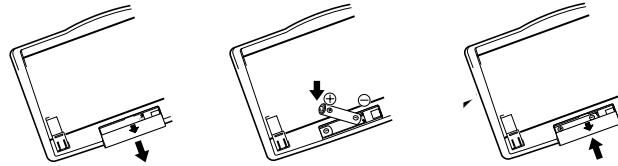

Remote control range:

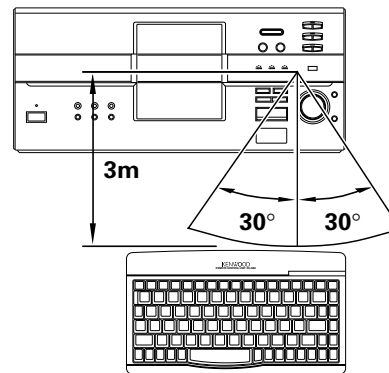

- When the controllable distance of the keyboard remote reduces, replace both batteries with new ones.

1-4 STANDBY mode

While the "STANDBY" indicator of the unit is lit, a small amount of current is flowing into the unit's internal circuitry to back up the memory. This condition is referred to as the standby mode of the unit. While the unit is in the standby mode, it can be turned on from the remote control unit.

1-5 Connection of Video Outputs

This unit can be connected to a TV through the following connections.

- Composite VIDEO OUTPUT connectors
- S-VIDEO OUTPUT connectors
- COMPONENT VIDEO OUTPUT connectors
- SCART connector (For Europe and U.K.)

Select the connection according to the TV to be connected.

After connecting the TV, be sure to change the setup of the unit according to the TV.

- Do not insert the power cord plugs of the player and the connected components until all of the components have been connected.
- For details on the connection terminals and functions of the TV, refer to its instruction manual.

1-5-1 To Set Up of the Player

Setup of Menu screen: The language to be used in the menus of the player can be selected.

"Player Menu Language" Setting →

- The default language set at the factory is English.

Setups Related to TV: The following setups can be made according to the TV connected to the player.

"TV Aspect" Setting →

"TV Mode" Setting →

"TV Monitor Type" Setting →

Setup of SCART output signals: The signals output from the **TV SCART** connector of the player can be selected.

"SCART Output Select" Setting →

1-5-2 Connection

a : Composite video connection

Connect the **VIDEO OUTPUT** terminal to the video input of the TV using the provided video cable.

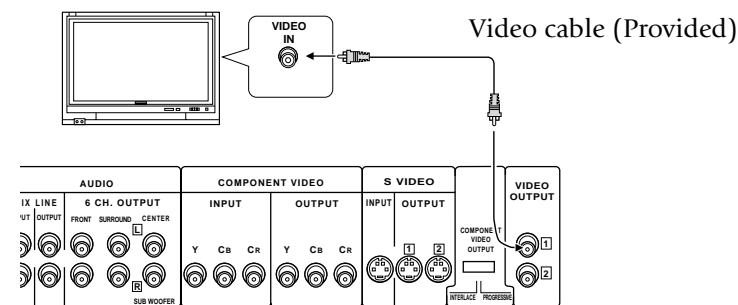

Illust Model : DV-5900M

b : S Video connection

If the TV has an S Video input connector, connect the **S VIDEO OUTPUT** connector of the player to it using the provided S Video cable.

- As S Video separates video signal into the brightness signal (Y) and color signal (C), it can provide sharper pictures than composite video connection.

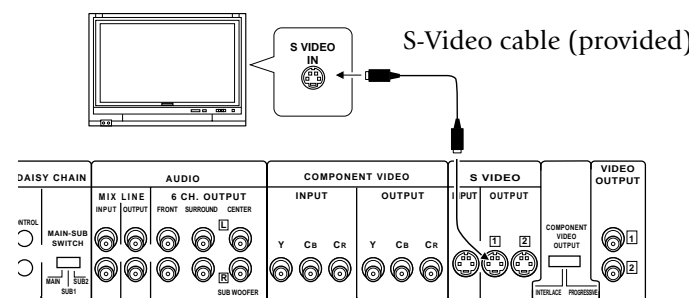

Illust Model : DV-5900M

- If both connections "**Composite video connection**" and "**S Video connection**" are made, "**S Video connection**" is used in priority on the main unit.
- For details on the connection terminals and functions of the TV, refer to its instruction manual.

C : Component video connection

If the TV has component video input terminals, connect the **Y, Cb** and **Cr COMPONENT VIDEO OUTPUT** terminals to the corresponding jacks on the TV using video cables.

- As component video separate video signal into the brightness signal (**Y**) and color difference signals (**Cb, Cr**), it can provide sharper image than the S Video connection.
- Depending on the TV or video monitor in use, the terminal names may be different from those used with the player (Y/Pb/Pr or Y/B-Y/R-Y, etc.)
- When the TV in use is a HDTV or "Hi-Vision" TV, connect the component video signals from the player only to the DVD-compatible input jacks.

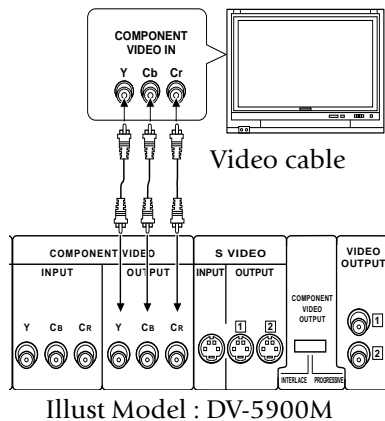
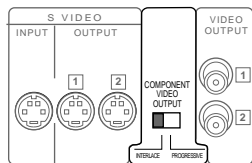
**COMPONENT VIDEO OUTPUT switch (NTSC Format only)**

Select the scanning method of the Component Video output using the **COMPONENT VIDEO OUTPUT** switch on the rear panel.

INTERLACE : Scanning method is fixed at interlaced scanning.

PROGRESSIVE : When progressive scanning is unavailable with certain discs, the scanning method is switched automatically to interlaced scanning. When the unit is performing progressive scanning, "**PROGRESSIVE**" light in the display.

d : SCART connection (For Europe and U.K.)

If the TV or VCR has SCART connectors, connect the **TV SCART** or **VCR SCART** connector of this unit to the TV or VCR using SCART cables.

- The audio and video signals can be output using a single cable. The signal output from the **TV SCART** connector can be switched between composite video, S Video and RGB. (The **VCR SCART** connector always outputs composite video signals so its output signals cannot be selected.)
- When the TV is connected through a VCR using SCART connection, the picture displayed on the TV may be disturbed due to the copy protect function.
- When using only the TV and VCR which are both connected with the player using the SCART connection, the signal from the VCR cannot be sent to the TV if the player is switched off. (In this case, set the player to the power standby mode.)
- When the **COMPONENT VIDEO OUTPUT** connectors are used, do not set "**SCART Output Select**" in the Set Up menu to "**RGB**".

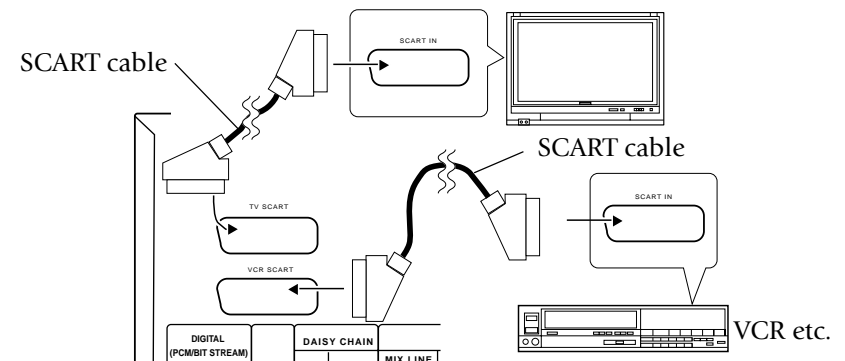

1-6 Connection of Audio Output

Do not insert the power cord plugs of the player and the connected components until all of the components have been connected.

For details on the connection terminals and functions of the AV amplifier, refer to its instruction manual. The video output from the player should be connected directly to the AV amplifier. If the video output is connected through a VCR, the picture displayed on the TV may be disturbed due to the copy protect function.

1-6-1 : 2-channel stereo connection

You can enjoy stereo sound if you connect the TV or system component that has 2-channel stereo connection.

DV-5900M

Connect to the **MIX LINE OUTPUT** connectors.

DV-5050M/DVF-J6050

Connect to the **MIX LINE OUTPUT** or **AUDIO OUTPUT L/R** connectors.

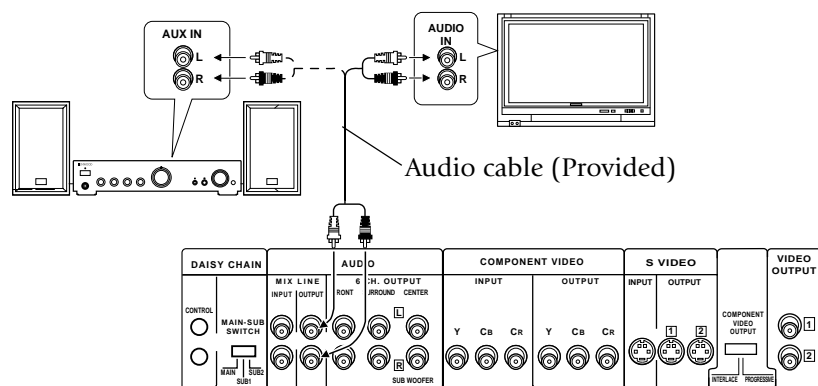

Illust Model : DV-5900M

- When playing a disc containing MPEG multi-channel audio recording, connect the stereo input to the **6ch OUTPUT L/R** terminals and activate the DOWN MIX function (→  44). (DV-5900M only)
- Read the instructions for the TV and speakers or system component for connection details.

For DV-5050M/DVF-J6050

DTS disclaimer clause

When playing DTS-encoded (CDs, LDs, DVDs), excessive noise will be exhibited from the analog stereo outputs. To avoid possible damage to the audio system, the consumer should take proper precautions when the analog stereo outputs of the DVD player is connected to an amplification system. To enjoy DTS Digital Surround™ playback, an external 5.1 channel DTS Digital Surround™ decoder system must be connected to the digital output (S/P DIF, AES/EBU, or TosLink) of the DVD player.

For DV-5900M

DTS disclaimer clause

DTS Digital Surround™ is a discrete 5.1 channel digital audio format available on CD, LD, and DVD software which consequently cannot be decoded and played back inside most CD, LD, or DVD players. For this reason, when DTS-encoded software is played back through the analog outputs of the CD, LD, or DVD player, excessive noise will be exhibited. To avoid possible damage to the audio system, proper precautions should be taken by the consumer if the analog outputs are connected directly to an amplification system. To enjoy DTS Digital Surround™ playback, an external 5.1 channel DTS Digital Surround™ decoder system must be connected to the digital output (S/P DIF, AES/EBU, or TosLink) of the CD, LD or DVD player.

This unit is equipped with DTS Digital Surround™ decoder.

1-6-2 : 6 channel (5.1 ch) audio connection (DV-5900M only)

When the connected AV amplifier has 6-channel audio input terminals, Please connect the **6CH. OUTPUT** terminals to them.

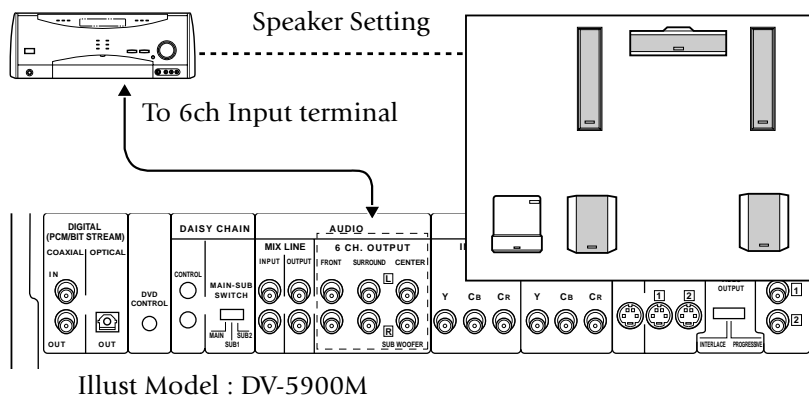
**Setup for 6-channel audio connection:**

- When the audio is connected using the **6CH. OUTPUT** terminals, set the player as follows. "**Speaker Setting**" → 78
- When a DVD AUDIO disc is played, the player can output audio signals at very high frequencies. As this may sometimes lead to speaker damage due to a high-volume sound, do not set "**Audio Filter**" to "**Filter 110 kHz**" when the speakers in use are not suitable for high-frequency reproduction. → 77
- When connection of 3 or more channels is required, connect the audio inputs to the **6ch OUTPUT** connectors on the rear panel according to the speakers in use.

After connection, set the non-used speakers to "**OFF**" with the "**Speaker setting**" function. → 78

1-6-3 : Digital output connection

Use the **DIGITAL** output terminal when using an external decoder (or an AV amplifier with built-in decoder) to decode Dolby Digital and DTS Digital Surround signals.

To use the external decoder, it is required to change the "**SOUND**" setup in the Set Up menu. → 76

Speaker setting

The speakers are to be set up on the amplifier. → 78

Audio filter (Speaker protect)

The audio filtering is to be set up on the amplifier. → 77

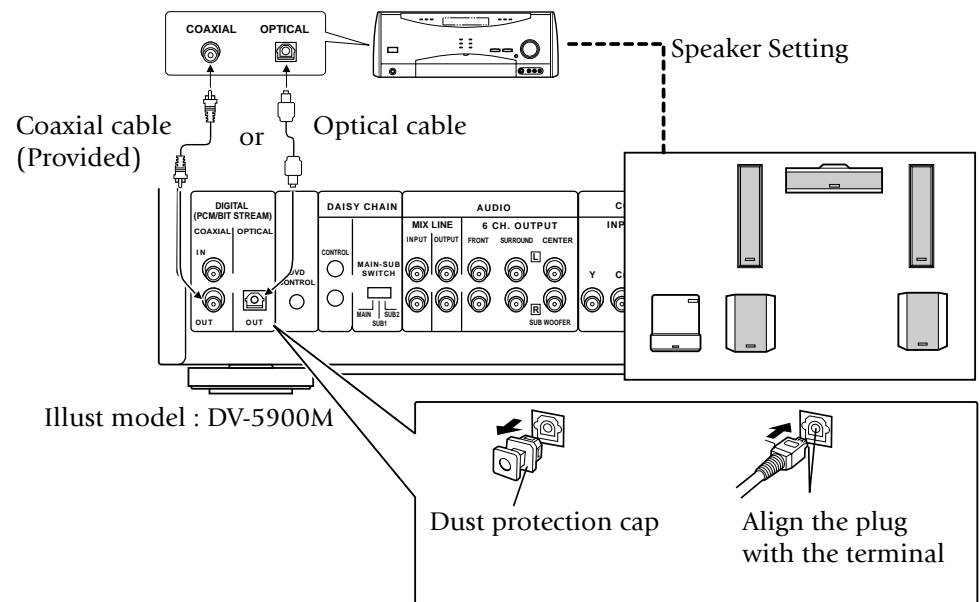
**Note : When connecting the optical digital audio cable**

- Remove the dust protection cap from the optical digital audio output terminal and connect the cable firmly so that the configurations of both the cable and the terminal match.
- Keep the dust protection cap and reattach when not using the terminal.

a : External decoder type & SetUp menu "sound"

External decoder type / Setup Function	Dolby Digital decoder	DTS Digital Surround decoder	MPEG decoder	Dolby Digital/DTS Digital Surround decoder	Dolby Digital/DTS Digital Surround/MPEG decoder	No decoder
PCM Down Conversion	Yes*	Yes*	Yes*	Yes*	Yes*	Yes*
Dolby Digital	Bitstream	PCM	PCM	Bitstream	Bitstream	PCM
DTS Digital Surround	DV-5900M PCM Other Off	DV-5900M Bitstream Other Bitstream	DV-5900M PCM Other Off	DV-5900M Bitstream Other Bitstream	DV-5900M Bitstream Other Bitstream	DV-5900M PCM Other Off
MPEG Multi channel	PCM	PCM	Bitstream	PCM	Bitstream	PCM

* If this is set to "No", no audio will be output when DVDs recorded in 96 kHz linear PCM are played. (Audio will be output as it is the DVD does not have copyright protection recorded on it.)

These changes to digital audio output must be made, otherwise bitstream signals the decoder cannot handle will be output. If these signals are output, "noise" will be output which can cause harm to your ears and speakers.

1-7 Daisy Chain Connection

Up to three changer units can be connected in series.

- The three units can mutually control other units.
- Up to 1200 discs can be played back continuously by connecting three units.
- Relay playback, with which discs are played in a random order is possible.

Relay playback cannot control discs in the PLUS1 to PLUS3 slots.

Random relay playback cannot play discs in the PLUS1 to PLUS3 slots.

Daisy Chain Connection

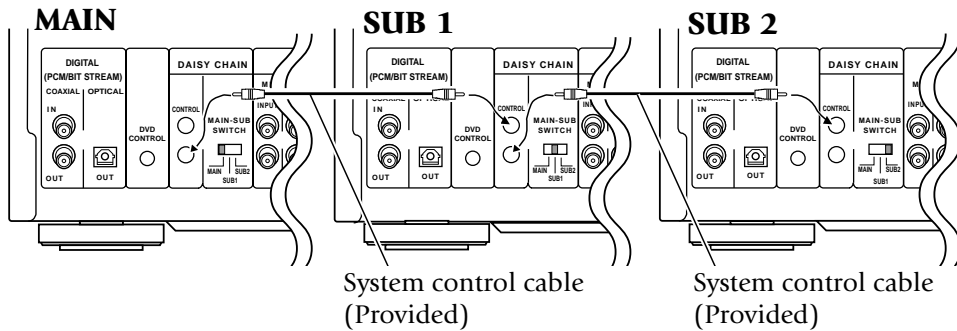

1-7-1 Setup

Set the **MAIN-SUB SWITCH** on the rear panel of each changer unit to a different position from other changer units.

Be sure to unplug the power cord before changing the position of the **MAIN-SUB SWITCH**.

Be sure to set one of the **MAIN-SUB SWITCH** to "MAIN".

It is the unit set as the "MAIN" unit that manages the discs and output the playback signals to speakers.

When peripheral equipment (TV, AV amp, etc.) is used, connect it to the unit set as the "MAIN" unit. "Daisy Chain Function"

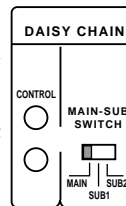

1-7-2 Connection of Video Output Terminals

Connect the video output using either the S-VIDEO or COMPONENT VIDEO connection.

For the connection, connect the "SUB2" unit output to the "SUB1" unit input, then connect the "SUB1" unit output to the "MAIN" unit input as shown in the figure below.

Example Using S-VIDEO Connection

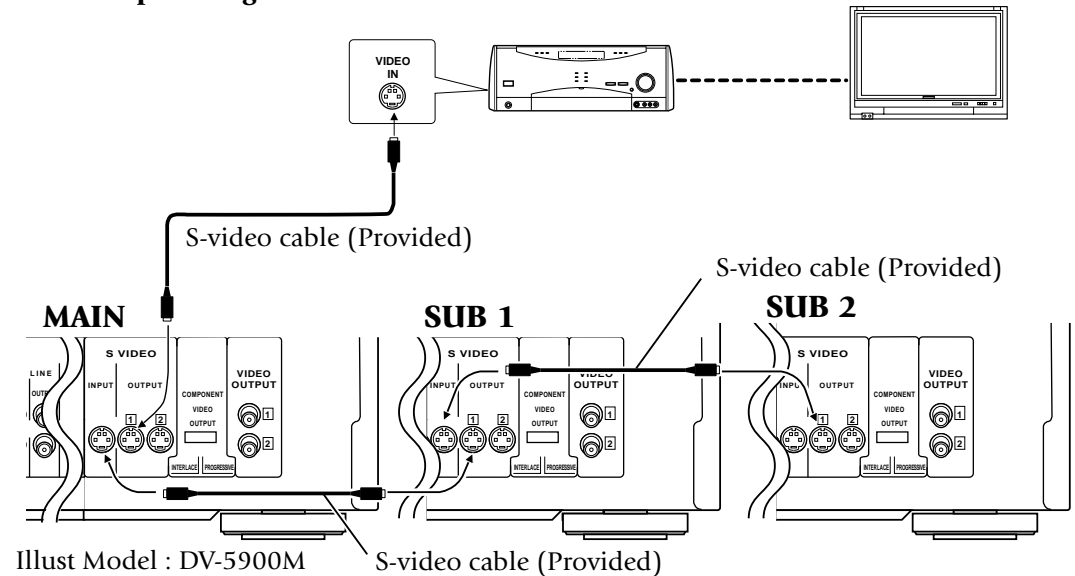

Illust Model : DV-5900M

1-7-3 Connection of Audio Output Terminals

Connect the audio output using either the **“Digital”** or **“Analog”** connection (see figure on the right).

For the connection, connect the **“SUB2”** unit output to the **“SUB1”** unit input, then connect the **“SUB1”** unit output to the **“MAIN”** unit input.

Connection and Setup

Use the **“Analog”** connection when any of the following types of discs is included.

- A disc containing the recording of MP3 files.
- DVD-AUDIO disc (DV-5900M only)

When using the **“Digital”** connection:

Set the **“PCM Down conversion”** setup to **“On”**. 

When both **“Analog”** and **“Digital”** connections are connected :

The Digital connection is used in priority when the input mode of the receiver is set to the **“AUTO”** position.

To use the Analog connection, switch the input mode of the receiver to **“Analog”** position.

Analog Audio Connection

- When playing a disc containing MPEG multi-channel audio recording, connect the stereo input to the **6ch OUTPUT L/R** terminals and activate the DOWN MIX function (). (DV-5900M only)

Digital Audio Connection

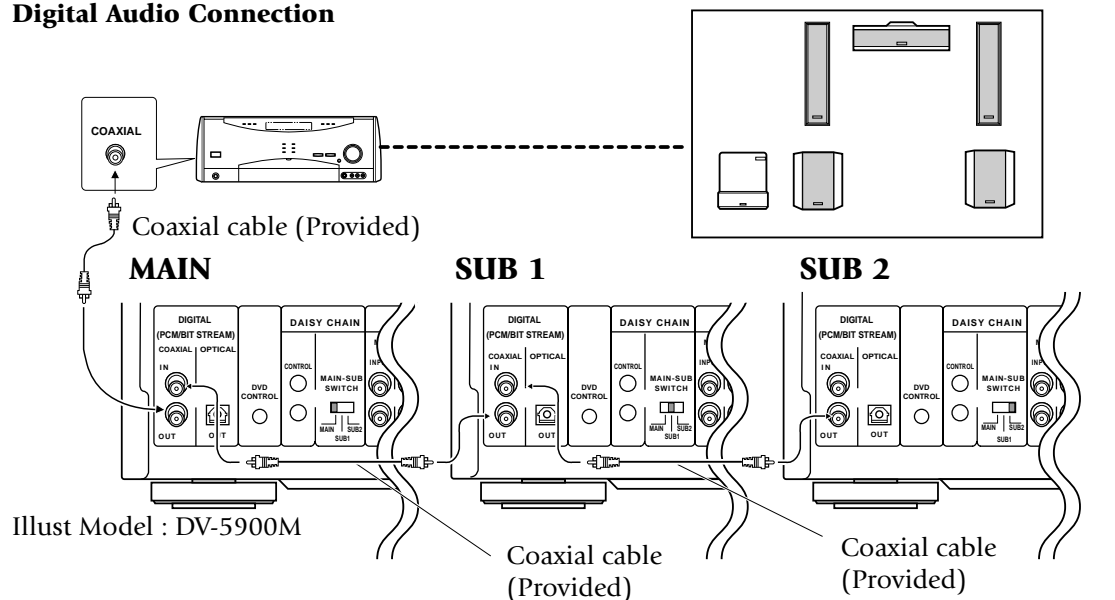

Analog Audio Connection

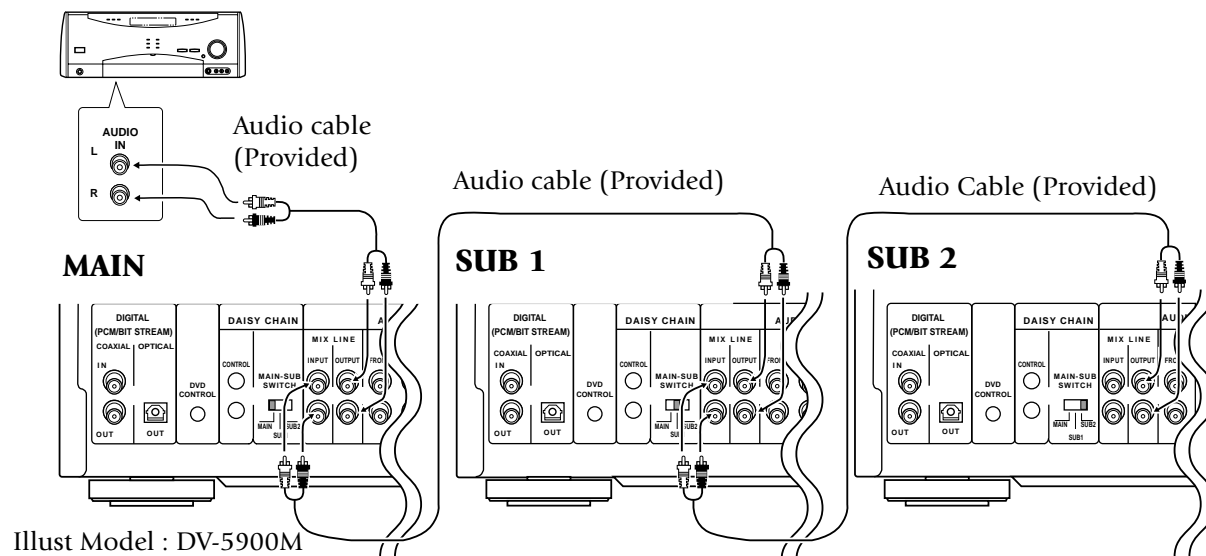

1-8 PC Link Connection

PC LINK function, which allows you to connect your PC to the DVD mega-changer and download disc titles and track data from an Internet site and register them in the DVD mega-changer.

<http://www.kenwoodusa.com>

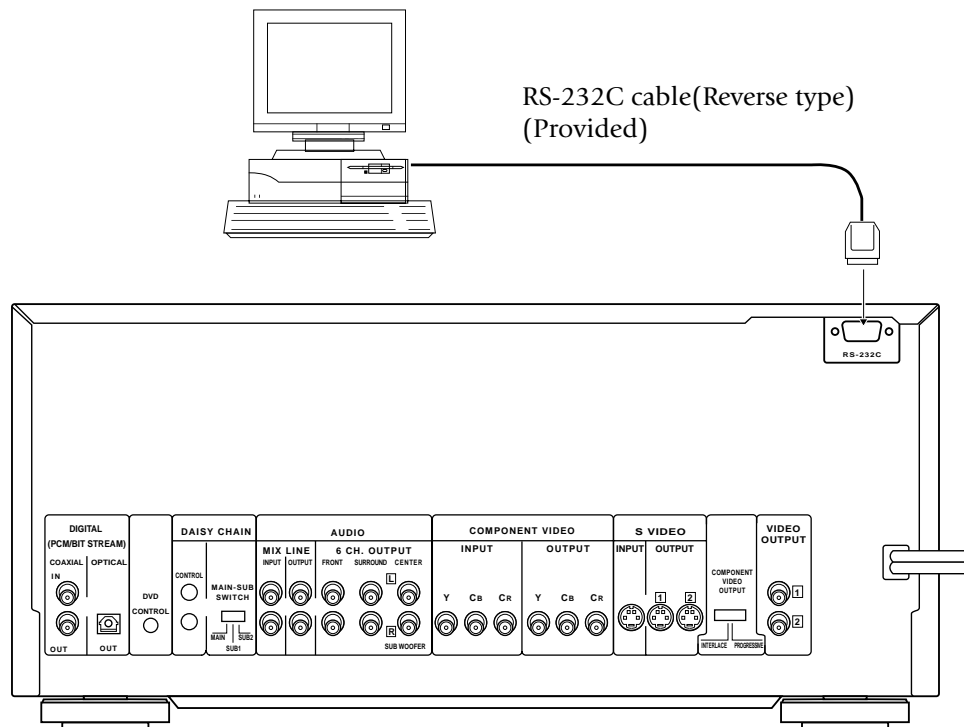

Illust Model : DV-5900M

1-9 DVD Control Function

(Except for DVF-J6050 Asia version)

The basic operations of this unit, such as playback and stop, can be remote controlled from the LCD remote control unit provided with a KENWOOD AV receiver*.

- Connect the DVD control terminal of the AV receiver to the **DVD CONTROL** terminal of this unit using a system control cable.

* The receiver should be equipped with the DVD control function.

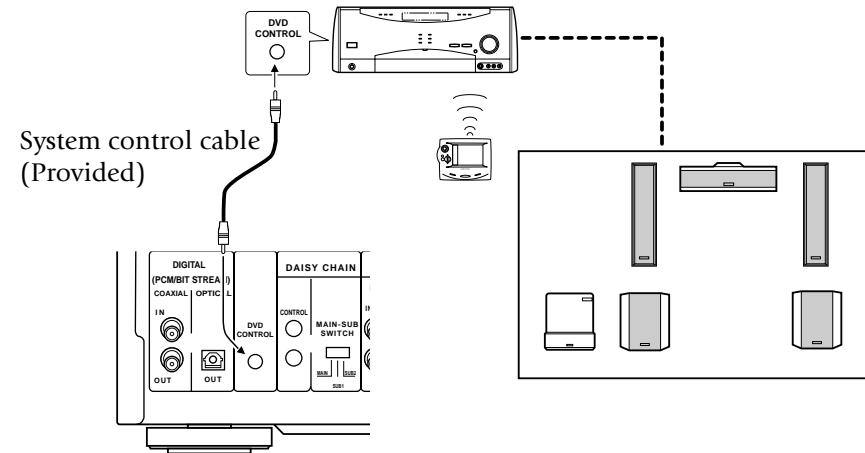

Chapter 2: Controls and indicators

2-1 Introduction

This chapter gives description on the front panel buttons, display panel of the player main unit and the provided remote control unit.

This chapter is composed of the following sections.

Front Panel	→ 22
Display	→ 23
Standard Remote Control unit	→ 24
Keyboard Remote Control unit	→ 26

2-2 Front Panel

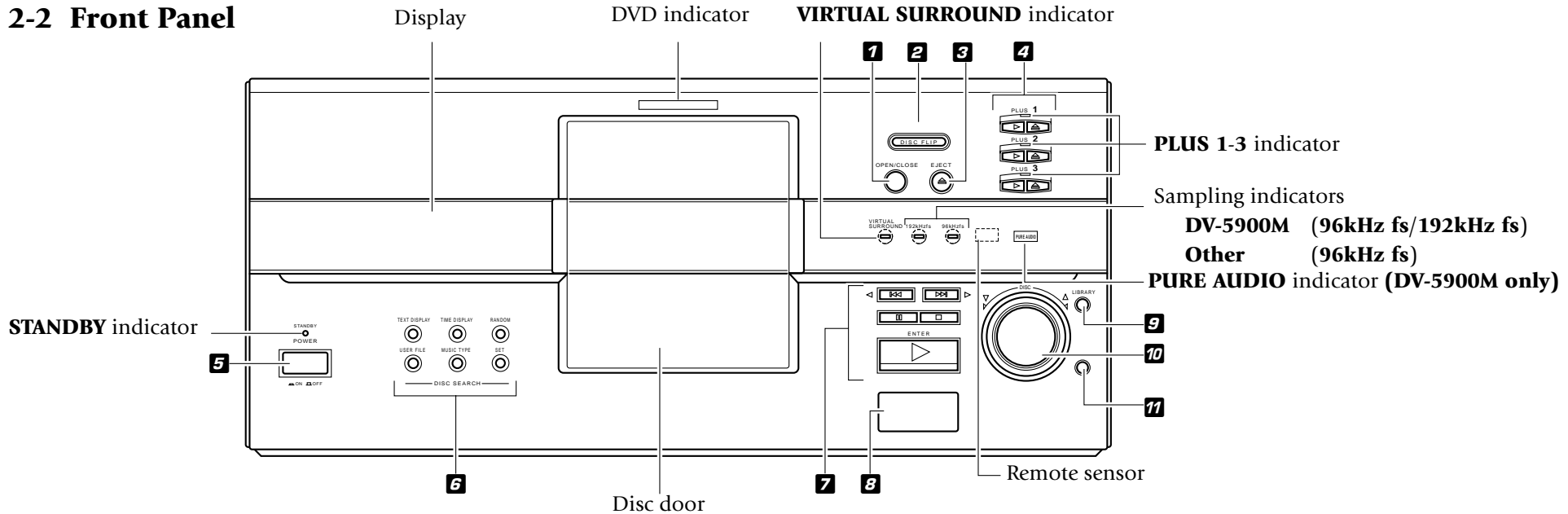

- | | | | |
|--|------|--|-----------|
| 1 OPEN/CLOSE button | → 29 | USER FILE button | → 66 |
| 2 DISC FLIP button | → 53 | MUSIC TYPE button | → 65 |
| 3 EJECT button | → 29 | SET button | → 65 → 66 |
| 4 PLUS 1 ► (play), ▲ (eject) button | → 30 | 7 ◀◀ button | → 31 |
| PLUS 2 ► (play), ▲ (eject) button | → 30 | Functions as the [cursor left] button in the LIBRARY mode. | → 70 |
| PLUS 3 ► (play), ▲ (eject) button | → 30 | ▶▶ button | → 31 |
| 5 POWER button | → 28 | Functions as the [cursor right] button in the LIBRARY mode. | → 70 |
| 6 TEXT DISPLAY button | → 51 | ⏸ (pause, still) button | → 31 |
| TIME DISPLAY button | → 36 | ■ (stop) button | → 31 |
| RANDOM button | → 50 | ▶ ENTER (play, enter) button | → 30 |
| | | 8 LCD remote transmitter | |
| | | The disc and track title data are output to the LCD remote control unit (provided with a KENWOOD Receiver or optional) through this window. | |
| | | 9 LIBRARY button | → 66 |
| | | 10 DISC knob | → 29 |
| | | Functions as the [cursor up, down] button in the LIBRARY mode. | → 70 |
| | | 11 RETURN button | → 70 |
| | | Functions as the [return] button in the LIBRARY mode. Note that the function of the RETURN button on the main unit is deactivated in the LIBRARY mode. | |

2-3 Display

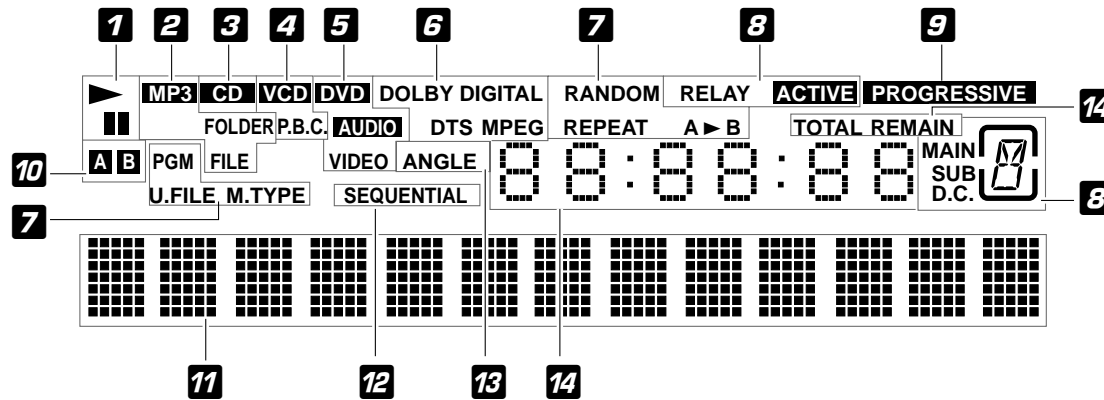

1 Operation indicators

2 MP3 indicator

"MP3" lights during playback of an MP3 file.

3 CD indicator → 30

4 VCD related indicators → 33

5 DVD related indicators

"AUDIO" and "VIDEO" light only with the DV-5900M.

6 Decoder related indicators

7 Special playback related indicator → 34 → 42 → 50

8 Daisy Chain function related indicators → 52

9 PROGRESSIVE indicators → 14

10 DVD reverse mode related indicators → 53

11 Character information display

12 SEQUENTIAL indicator → 34

Lights in the Sequential mode.

13 ANGLE indicator → 47

14 Time related indicators → 36

2-3-1 Switching the Display Brightness

Press the **DISP.** button on the remote to switch the display brightness in the following sequence.

"Brightness" : The display is permanently displayed in high brightness.

"Dimmer" : The display is permanently displayed in low brightness.

"Auto Off" :

The display status becomes as follows.

With a disc containing video, such as DVD or VCD

During playback : Goes Off

During stop: **"Brightness"** status

Other operation than playback: **"Brightness"** status for 3 seconds.

With a disc without video, such as CD or MP3

The display remains in the **"Brightness"** status.

"FL OFF" : The display is turned off.

2-4 Standard Remote Control Unit

The buttons with the same names as those on the player main unit have the same functions as the main unit buttons.

For DV-5900M

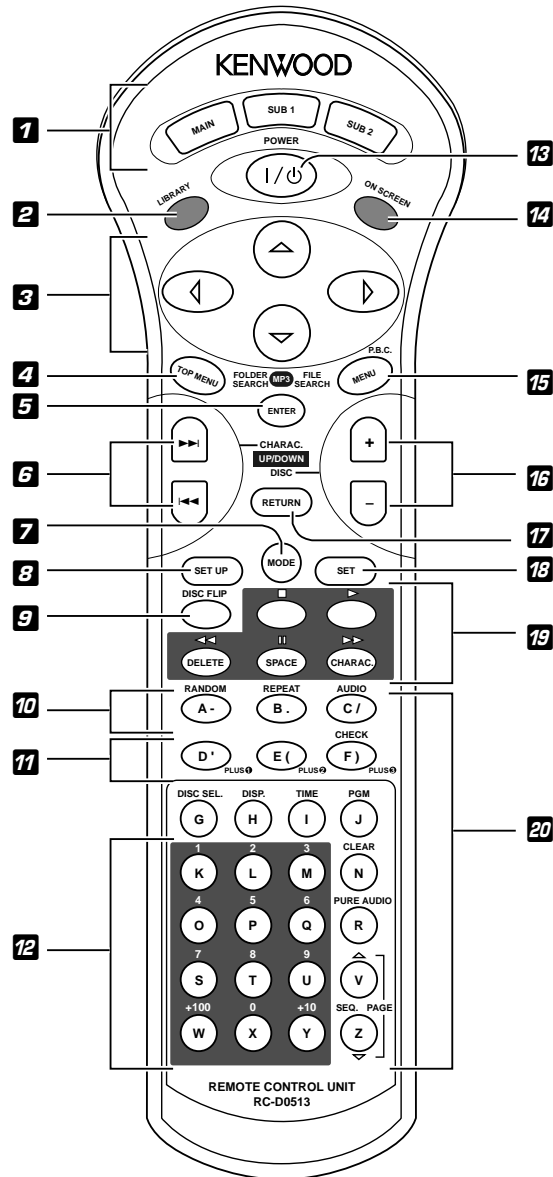

1 Daisy Chain related buttons

- MAIN** button → 52
- SUB 1** button → 52
- SUB 2** button → 52

2 **LIBRARY** button → 66

3 Cursor buttons → 33 → 38

4 **TOP MENU** button → 33

FOLDER SEARCH button → 70

5 **ENTER** button → 30 → 33

6 **◀◀, ▶▶** buttons → 31 → 33

7 **MODE** button → 29 → 55

8 **SET UP** button → 53 → 72

9 **DISC FLIP** button → 53

10 **RANDOM** button → 50

REPEAT button → 34

AUDIO button → 36

11 **PLUS 1** button → 30

PLUS 2 button → 30

PLUS 3 button → 30

CHECK button → 50

12 Numeric buttons → 30

13 **POWER** button → 28

14 **ON SCREEN** button → 38

15 **MENU** button → 33

FILE SEARCH button → 70

P.B.C. button → 33

16 **DISC +, -** (DISC up, down) buttons → 29

17 **RETURN** button → 33 → 38

18 **SET** button → 29

19 Basic operation related buttons

■ button → 31

▶ button → 30

◀◀ button → 32

|| button → 31

▶▶ button → 32

Character input operation related buttons

DELETE button → 60

SPACE button → 59

CHARAC. button → 59

20 **Characters and symbol buttons** → 59

+100 button → 30

+10 button → 30

Special playback related buttons

DISC SEL. button → 30

DISP. button → 23

TIME button → 36

PGM button → 49

CLEAR button → 50

PURE AUDIO button → 36

SEQ. button → 34

PAGE Δ, ▽ buttons → 34

The buttons with the same names as those on the player main unit have the same functions as the main unit buttons.

For DV-5050M/DVF-J6050

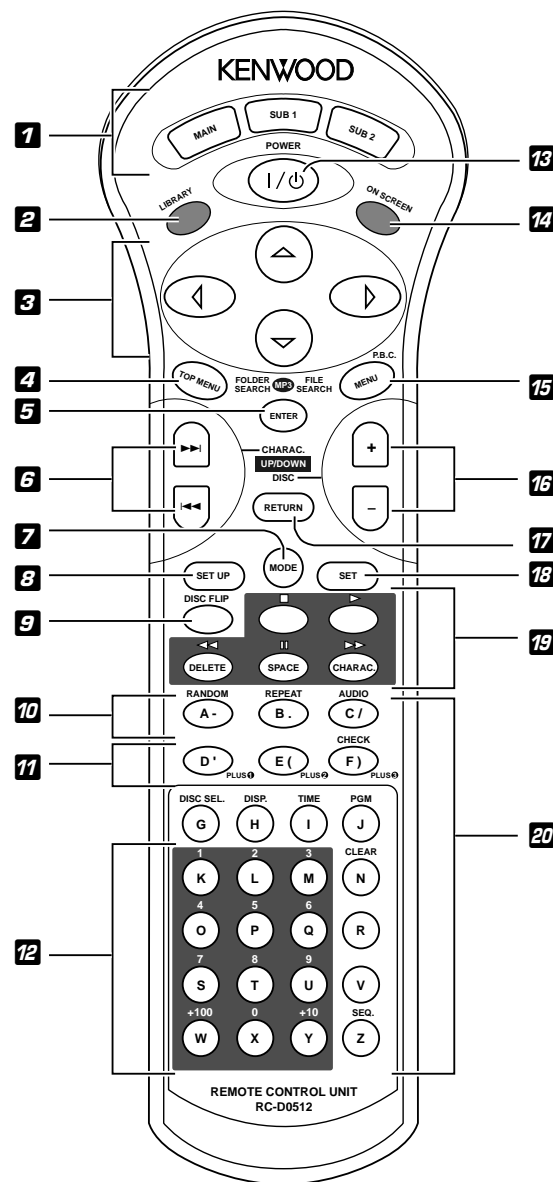

- | | | |
|--|---|---------|
| 1 Daisy Chain related buttons | | |
| MAIN button | → | 52 |
| SUB 1 button | → | 52 |
| SUB 2 button | → | 52 |
| 2 LIBRARY button | → | 66 |
| 3 Cursor buttons | → | 33 → 38 |
| 4 TOP MENU button | → | 33 |
| FOLDER SEARCH button | → | 70 |
| 5 ENTER button | → | 30 → 33 |
| 6 ◀◀, ▶▶ buttons | → | 31 → 33 |
| 7 MODE button | → | 29 → 55 |
| 8 SET UP button | → | 53 → 72 |
| 9 DISC FLIP button | → | 53 |
| 10 RANDOM button | → | 50 |
| REPEAT button | → | 34 |
| AUDIO button | → | 36 |
| 11 PLUS 1 button | → | 30 |
| PLUS 2 button | → | 30 |
| PLUS 3 button | → | 30 |
| CHECK button | → | 50 |
| 12 Numeric buttons | → | 30 |
| 13 POWER button | → | 28 |
| 14 ON SCREEN button | → | 38 |
| 15 MENU button | → | 33 |
| FILE SEARCH button | → | 70 |
| P.B.C. button | → | 33 |
| 16 DISC +, - (DISC up, down) buttons | → | 29 |
| 17 RETURN button | → | 33 → 38 |
| 18 SET button | → | 29 |
| 19 Basic operation related buttons | | |
| ■ button | → | 31 |
| ▶ button | → | 30 |
| ◀◀ button | → | 32 |
| button | → | 31 |
| ▶▶ button | → | 32 |
| Character input operation related buttons | | |
| DELETE button | → | 60 |
| SPACE button | → | 59 |
| CHARAC. button | → | 59 |
| 20 Characters and symbol buttons | → | 59 |
| +100 button | → | 30 |
| +10 button | → | 30 |
| Special playback related buttons | | |
| DISC SEL. button | → | 30 |
| DISP. button | → | 23 |
| TIME button | → | 36 |
| PGM button | → | 49 |
| CLEAR button | → | 50 |
| SEQ. button | → | 34 |

2-5 Keyboard Remote Control Unit (DV-5900M only)

The buttons with the same names as those on the player main unit have the same functions as the main unit buttons.

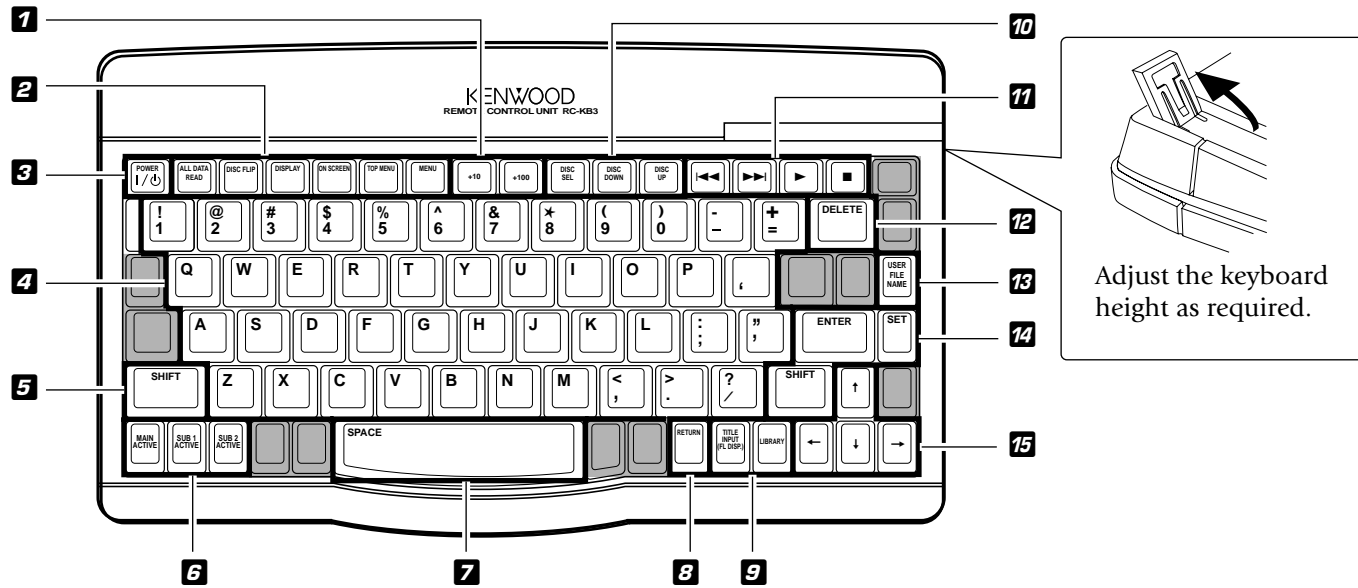

1 +10 button
+100 button

2 DVD operation related buttons
ALL DATA READ button
DISC FLIP button
DISPLAY button
ON SCREEN button
TOP MENU button
MENU button

3 POWER button

4 Character and symbol buttons

5 SHIFT button
6 Daisy Chain related buttons

MAIN ACTIVE button
SUB 1 ACTIVE button
SUB 2 ACTIVE button

7 SPACE button
8 RETURN button
9 TITLE INPUT (FL DISP.) button
LIBRALY button

10 Disc selection related buttons
DISC SEL button
DISC DOWN button
DISC UP button

11 Basic operation related button
|◀◀, ▶▶| buttons

▶ button
■ button

12 DELETE button

13 USER FILE NAME button

14 Entry/setting related buttons
ENTER button
SET button

15 Cursor buttons

→ **31** → **33**

→ **32**

→ **31**

→ **60**

→ **60**

→ **30** → **33**

→ **60**

→ **33** → **38**

Chapter 3 : Basic Operation

3-1 Introduction

This chapter gives description on the basic operations of the control buttons on the player main unit and remote.

This chapter is composed of the following sections.

Configuration of Discs	→ 28	Switching the sequential play mode	→ 34
Turning power on	→ 28	Repeat playback	→ 34
Inserting discs	→ 29	Switching the time display	→ 36
In regard to ALL DATA READ mode	→ 29	Pure Audio function	→ 36
Operation restriction according to the disc or player status	→ 30	Switching the audio language	→ 36
Playing discs	→ 30		
PLUS1 to PLUS3 slots	→ 30		
Playing discs by changing them	→ 30		
Playing from the selected disc	→ 30		
Playing discs by selecting the title, chapter, track or file	→ 31		
Skipping a track, chapter or file	→ 31		
Stopping playback	→ 31		
Still picture display and playback pause	→ 31		
Frame-by-frame advance	→ 31		
Forward search and reverse search	→ 32		
Slow playback and reverse slow playback...	→ 32		
What is the “normal play TRACK mode”? ...	→ 32		
Menu playback of DVD	→ 33		
Menu playback of P.B.C.-compatible VCD ..	→ 33		
Switching still pictures of DVD AUDIO	→ 34		

3-2 Configuration of Discs

DVD AUDIO disc configuration (DV-5900M only)

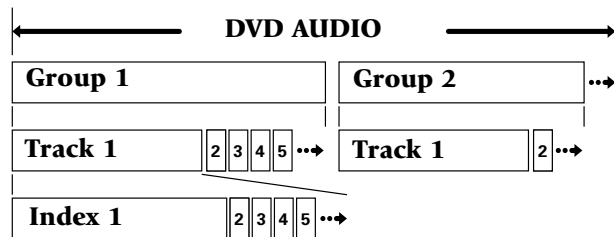

The group is the largest unit composing the music in an DVD AUDIO disc. Each group is composed of multiple tracks, and each track is composed of multiple indices.

DVD VIDEO disc configuration

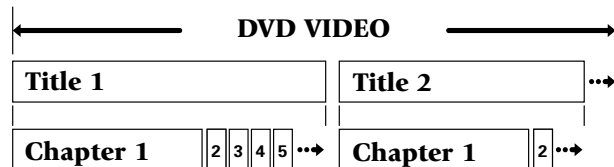

The title is the largest unit composing the music and/or pictures in an DVD VIDEO disc. Each title is composed of multiple chapters.

CD and VCD disc configuration

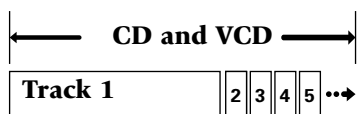

MP3 disc configuration

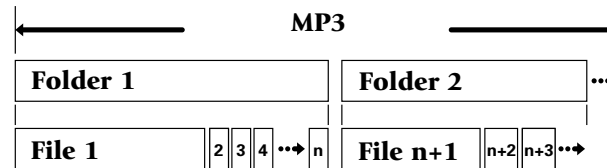

Configuration of MP3 discs

The folder is the storage unit at the highest level in the disc. Sometimes a single folder contains more than one file, or sometimes files are recorded directly in the disc in place of being included in a folder. Some discs also have a hierarchical structure in which a folder includes sub-folders. Note that the file numbers are not assigned on a per-folder basis but they are assigned consecutively for all the files in the whole disc.

3-3 Turning power on

Operation procedure

1. If preparation of the TV is required :

Set the input selector of the TV to monitor the video output from this unit.

If preparation of the AV amplifier is required :
Set the input selector of the AV amplifier to monitor the audio output from this unit.

2. Press the **POWER** button on the player.

When the power of the player is in the standby mode, press the **POWER** button on the remote.

- When power is switched on, the unit starts detection of discs in the stocker ("DETECTION" is displayed during this).

When discs have been detected, the unit automatically reads TOC on discs ("READING" is displayed during this) then starts playback.

- When no disc has been detected, the display shows "NO DISC".

[To put the player power in the standby mode]

- When the power is on, press the **POWER** button on the remote. The "STANDBY" indicator lights up to indicate that the player is in the standby mode of power.

[To turn the player off]

- When the power is on or standby, press the **POWER** button on the player to turn it off.

3-4 Inserting discs

Up to 403 discs can be loaded in the stoker. Disc exchange also is possible during playback.

The discs can be changed during playback without stopping the currently played disc.

Be sure to operate a button when opening/closing the disc door or rotating the stoker. Never attempt to move the stoker with your hand. Never let your hand or any object enter inside the unit.

Operation procedure

1. Press the **OPEN/CLOSE** button on the player main unit to open the disc door. (Pressing the button again closes the disc door.)

This unit cannot play back 8 cm discs. Do not attempt to play an 8 cm disc for this may result in malfunction.

- Place the disc to be played along the groove on the slot.
 - Do not insert more than one disc in a slot.
 - When handling a disc, take care not to touch the disc surface.
 - Please do not use discs which are not round because they may cause malfunction.
2. Turn the **DISC** knob and bring the slot with the disc to be placed to the front.
 - If you are operating the remote, press the **DISC** +(up), – (down) button.

3. Insert the disc vertically.

- Insert it so that the side to be played back faces leftward.

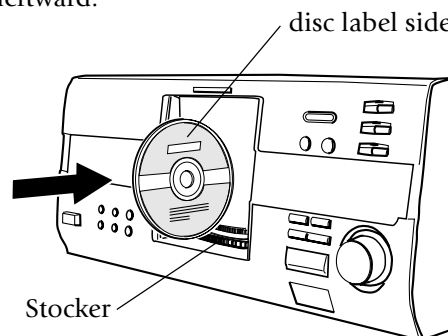

4. Repeat 2 and 3 to insert discs.

5. Press the **OPEN/CLOSE** button on the player to close the disc door.

- When the disc door closes :

The unit starts detection of discs in the stoker ("DETECTION" is displayed during this).

Ejecting the disc

Operation procedure

1. Turn the **DISC** knob on the main unit to select a disc.
2. Press the **EJECT** ▲ button.

When "REMOVE DXXX" is displayed :

A disc is inserted in the slot with the same disc number as the disc being loaded. It is not permitted to insert another disc in a slot from which the disc has been loaded. Remove the inserted disc and insert it in an idle slot.

3-5 In regard to ALL DATA READ mode

The disc information for all discs will be read. We recommend to execute this mode before playback after discs have been exchanged.

Close the disc door before operation.

Operation procedure (remote)

1. Press the **MODE** button.
2. Press the **DISC** +(up), – (down) button, then select "ALL DATA READ".
3. Press the **SET** button.

- To display the title on a LCD remote control unit (provided with a KENWOOD Receiver or optional), perform the all data read operation first, and operate the LCD remote control unit with the disc door closed. For the operation of the LCD remote control unit, refer to the instruction manual provided with your receiver or LCD remote control unit.
- If you are operating the keyboard remote, press the **ALL DATA READ** button. (DV-5900M only)
- To quit ALL DATA READ mode, Press the ■ button.

3-6 Operation restriction according to the disc or player status

Operations of some DVDs and VCDs are restricted by the intention of the software producers. Operations may also be restricted due to the status of the player.

As this player plays discs in accordance with the intentions of software producers, some functions may not work as intended by the user. Be sure to read the manual provided with the disc to be played. When an inhibition icon is displayed on the connected TV screen during operation, it indicates that the player is in the operation restricted status.



Inhibition icon

3-7 Playing discs

Press the ► button in stop mode to start playback.

- When you are operating the remote, press the ► or **ENTER** button.
- The TV screen shows "**Play**" and the ► indicator in the display lights up.
- The type of the disc being played is shown on the display. → 23
- Certain CD-R and CD-RW discs may not be playable on this player.
- The **CD** indicator lights when a CD-DA disc is loaded.
- When a disc containing MP3 files is played, the "**MP3**" indicator lights.

- When the loaded disc contains text data such as the disc title, the text will be scrolled on the display on this player.

"**Registration of Title**" → 61

- With certain DVD and VCD discs, a menu is displayed in the beginning.

"**Menu playback of DVD**" → 33

"**Menu playback of P.B.C.-compatible VCD**" → 33

3-8 PLUS1 to PLUS3 slots

Unlike the discs in other 400 slots, the discs in these slots can be played back by simply pressing the ► button, without the need of setting or selecting the disc number. Another feature of these slots is that they have wider areas around the grooves to facilitate insertion and ejection of discs.

Three PLUS slots, 1 to 3, are provided.

Operation procedure

1. Press the ► button of one of the PLUS1 to PLUS3 slots.
 2. The PLUS slot selected in step 1 moves to the center of the disc door, then the disc door opens.
 3. Insert a disc. → 29
 4. Press the ► button to start playing the disc.
 - When if you are operating the remote, press the **PLUS 1** to **PLUS 3** button.
- With the PLUS1 to PLUS3 slots, special playback such as program playback and random playback is not available.

3-9 Playing discs by changing them

Turn the **DISC** knob to skip a disc.

- When you are operating the remote, press the **DISC** +(up), – (down) button.
- The **DISC** knob in the player is invalid when the disc door is closed in the all random and program modes.
- When the sequential play mode of the player is set to "**Sequential On**", the DVD VIDEO is not played back. → 34

3-10 Playing from the selected disc

Operation procedure

1. Press the **DISC SEL.** button on the remote to select a disc.
2. Compose the disc number to be played using the 0 to 9, +10 and +100 buttons.

No 253 +100 x 2, +10 x 5, 3

No 120 +100, +10 x 2, 0
3. Press the ► button.
 - The **DISC SEL.** button is invalid in the all random and program play modes.
 - When the sequential play mode of the player is set to "**Sequential On**", the DVD VIDEO is not played back. In this case, playback starts with track 1 of the selected disc and continues on all other discs in the stocker except for DVD VIDEO discs. → 34

3-11 Playing discs by selecting the title, chapter, track or file.

Input the number of the title, chapter, track or file using **0** to **9**, **+10** and **+100** on the remote.

- With a DVD, when a number is input during playback, playback of the chapter or track having the same number as the input number in the same group or title starts. When a number is input in stop mode, playback the first chapter or track in the group or title having the same number as the input number starts.
- With a CD or VCD (when P.B.C. is off), playback starts with the beginning of the track having the same number as the input number.
- With a MP3 file, playback starts with the beginning of the file having the same number as the input number.

3-12 Skipping a track, chapter or file

Press the **◀◀** or **▶▶** button on the player.

- A track is skipped and playback starts from the beginning of the skip destination track, chapter or file.
- When the **◀◀** button is pressed once during playback, playback restarts from the beginning of the current track, chapter or file.
- With a VCD and P.B.C. is on, these buttons function as the **◀◀ (Previous)** and **▶▶ (Next)** button.

3-13 Stopping playback

Press the **■** button during playback. The first press activates the resume function and the second press stops playback.

- With certain DVDs, the inhibition icon is displayed and playback cannot be stopped even when the **■** button is pressed. In this case, turn the **DISC** knob to select another disc then press the **■** button to stop playback.

If there is only one disc in the stocker, open the disc door, place another disc, close the disc door, turn the **DISC** knob to select the second disc, then press the **■** button to stop playback.

- When you are operating the remote, press the **■** button.
- The resume function stores the position where playback is stopped in memory. Later, playback can be restarted from that position by pressing the **▶** button.
- While the resume function is activated, the "**▶**" indicator in the display blinks and shows the time of the stored position.
- The resume function cannot be activated during random playback, MUSIC TYPE PLAY mode and USER FILE PLAY mode.

3-14 Still picture display and playback pause

Press the **⏸** button during playback.

- This operation is not available with a MP3 disc. (DV-5900M only)
- The TV screen shows "**Pause**" or "**Still**" and the **⏸** indicator in the display lights up.
- To restart normal playback, press the **▶** button on the player.
- When the "**IPB Display**" is set to On, the TV screen shows "**Still (I)**", "**Still (P)**" or "**Still (B)**" with every still picture. → 74

3-15 Frame-by-frame advance

While a still picture of DVD or VCD is displayed, press the **⏸** button .

- The picture returns to still picture when the **⏸** button is released.
- The picture frame is advanced for the same number of times as the button is pressed. Hold the button when you want to advance picture frames sequentially.
- To restart normal playback, press the **▶** button on the player.
- When the "**IPB Display**" is set to On, the TV screen shows "**Still (I)**", "**Still (P)**" or "**Still (B)**" every time the picture frame is advanced. → 74

3-16 Forward search and reverse search

During playback, press the ◀◀ or ▶▶ button on the remote.

- This operation is not available with a MP3 disc. (DV-5900M only)
- When OSD is displayed, pressing the **ON SCREEN** button turns it off and shows the speed in place.
- The first press of the ◀◀ or ▶▶ button starts forward search or reverse search at the lowest speed step. Each further press increase the speed up to the fifth speed step.



The TV screen shows the speed as shown above. The indicator varies according to the speed of the forward search or reverse search.

The display of the player shows the time display or "**SEARCH >>**" according to the status of the disc and player.

Displayed during P.B.C. playback of VCD.

Displayed during playback of a DVD with which the time is not displayed.

- To restart normal playback, press the ▶ button on the player.
- Video may be disturbed during forward search or reverse search.
- When performing forward search with a VCD, DVD VIDEO or DVD AUDIO containing video and moving pictures (AVTT: Audio Video Title), the audio output can be switched on or off only while the search is at the lowest speed step. The audio is muted in the second and later speed steps. "**Audio During Search**" → 77

3-17 Slow playback and reverse slow playback

While a still picture is displayed, press the ◀◀ or ▶▶ button on the remote.

- This operation is not available with a MP3 disc. (DV-5900M only)
- When OSD is displayed, pressing the **ON SCREEN** button turns it off and shows the speed in place.
- The first press of the ◀◀ or ▶▶ button starts slow playback or reverse slow playback at the lowest speed step. Each further press increase the speed up to the fifth speed step.



The TV screen shows the speed as shown above. The indicator varies according to the speed of the slow playback or reverse slow playback.

The display of the player shows the time display or "**SLOW >>**" according to the status of the disc and player.

Displayed during P.B.C. playback of VCD.

Displayed during playback of a DVD with which the time is not displayed.

- To restart normal playback, press the ▶ button on the player.
- Audio is not output during slow playback or reverse slow playback.
- Reverse slow playback is not available with VCD.
- Slow playback and reverse slow playback are not available with CD (MP3) or DVD AUDIO containing only still pictures and audio (AOTT: Audio Only Title).

3-18 What is the "normal play TRACK mode"?

Playback is made from the first track. The normal playback mode is called TRACK mode.

To set the unit to the TRACK mode :

At the time of PGM mode : → 49

Press the **PGM** button.

At the time of MUSIC TYPE or USER FILE mode :

→ 56 → 57

Press the **MODE** button.

At the time of RANDOM mode : → 50

Press the **RANDOM** button.

- The "**RANDOM**" indicator turns off.

At the time of REPEAT mode : → 34

Press the **REPEAT** button.

- The "**REPEAT**" indicator turns off.

3-19 Menu playback of DVD

When a DVD containing the recording of the top menu or menu is played, the top menu or menu is displayed.

These menus allow you to select the position you want to play easily based on an interactive method. The following operation procedure is the basic procedure. The functions vary depending on certain softwares.

Operation procedure

1. Press the **TOP MENU** button to display the top menu.
 - When the **TOP MENU** button is pressed again while the top menu is displayed during playback, the played position returns to the position where the button was pressed for the first time and playback restarts from there.
2. Select the scene to be played by pressing the cursor button on the remote. (The scene may sometimes be selected using the numeric buttons.)
3. Press the **ENTER** button to play the DVD from the selected title.
 - To display multiple menus sequentially, repeat steps 2 and 3 above. If the menus are provided in a hierarchical structure, this operation allows you to move to the menus in the lower hierarchy level.
 - The **MENU** button on the remote is pressed, the menu is displayed. The operation is the same as that of the top menu.

3-20 Menu playback of P.B.C.-compatible VCD

When a P.B.C. (PlayBack Control) capable VCD is played with P.B.C. on, the menu is displayed. Perform operation according to the procedure indicated by the menu. (For details on the operation method and control buttons, refer to the manual provided with the played software.)

3-20-1 Hierarchical structure of VCD menus

When a P.B.C.-compatible VCD containing menu is played and an item is selected in the displayed menu, a menu with more detailed items may sometimes be displayed. Such a structure in which multiple menus are distributed in different levels and interconnected is referred to as the hierarchical structure. In this structure, the target scene can be reached by repeatedly selecting items in multiple menus.

Example of hierarchical structure

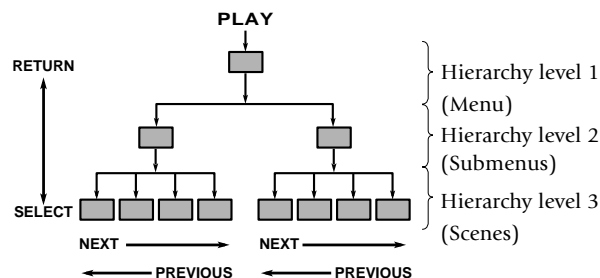

To advance in the hierarchy: When an item is selected in the menu using the **ENTER (Select)** button or numeric buttons, you can advance to the menu at the level immediately below the current level. When the selected item is a [scene], the scene will be played back.

To return in the hierarchy: You can return to the level immediately above the current level every time you press the **RETURN** button.

- When there are multiple menus (scenes) in a hierarchy level, they can be switched over by pressing the **◀◀ (Previous)** button or **▶▶ (Next)** button.

3-20-2 Main control buttons used in VCD playback, and examples of indications

Indication on software jacket	Control button on the player
▶ (Select)	ENTER button
↻ (Return)	RETURN button
◀◀ (Previous)	◀◀ button
▶▶ (Next)	▶▶ button

- The indication on the jacket is variable depending on the software.

3-20-3 Switching P.B.C. On and Off

- When there is a VCD in the played position of the stocker and the player is in stop mode, press **P.B.C.** button to switch P.B.C. on or off.

P.B.C. on: The TV screen shows "**P.B.C. On**" and the P.B.C.-compatible VCD is played according to P.B.C.

The "**P.B.C.**" indicator in the display lights up.

P.B.C. off: The TV screen shows "**P.B.C. Off**" and the P.B.C.-compatible VCD is played in normal playback without P.B.C.

The "**P.B.C.**" indicator in the display turns off.

- P.B.C. is switched off automatically when the sequential play mode is set to "**Sequential On**" or when the play mode is set to the program or random mode.

3-21 Switching still pictures of DVD AUDIO (DV-5900M only)

When a DVD AUDIO (AOTT: Audio Only Title) disc containing the recording of still pictures is played, the still pictures can be displayed. (The operation may be restricted with certain discs.)

To switch the still pictures, press the **PAGE** Δ or **PAGE** ∇ button on the remote during playback.

- Press the **RETURN** button to switch to the home still picture.

3-22 Switching the sequential play mode

The player is capable of sequential playback using the 400-disc stocker disc changer. If a DVD and/or VCD is mixed in the discs to be played sequentially, the sequential playback may stall in the middle while the menu remains displayed. In such a case, switch the sequential play mode of the player.

Set the sequential play mode of the player to "**Sequential On**" using the remote as described below. The DVD VIDEO playback will be skipped in order not to interrupt the sequential playback.

(The display shows "**SKIP DVD-V**" to indicate this.)
(DV-5900M)

(The display shows "**SKIP DVD**" to indicate this.)
(Other)

When playing a VCD with menu playback or playing a DVD VIDEO, set the sequential play mode of the player to "**Sequential Off**".

Operation procedure

1. Set the player to normal play mode (Track mode). →  32
 - Set the player to stop mode.
2. Each press of **SEQ.** button switches the sequential play mode of the player alternately.
 - The "**SEQUENTIAL**" indicator lights.
 - With a DVD AUDIO disc containing the recording of menu, menu playback is not available.
 - With a P.B.C.-compatible VCD, playback is performed by switching P.B.C. automatically to off.
 - When the sequential play mode is changed, "**Sequential Off**" or "**Sequential On**" is displayed on the TV screen.

3-23 Repeat playback

Repeat playback allows you to play the desired audio or video repeatedly.

Operation procedure

Press the **REPEAT** button during playback to display the "**MAIN**" OSD. Each further press of the button switches the repeat icons as shown. →  41

- This function may be unavailable with certain discs.
- If the on-screen message or OSD is displayed outside the TV screen when using a widescreen TV or similar monitoring device, set the "**OSD Position**" setting to "**Cinema**". →  74
- When the player is set to the repeat play mode, the "**REPEAT**" indicator in the display lights up. The character information display also shows the repeat mode information for a few seconds.
- This operation is not available with a DVD with which the elapsed play time information is not displayed.
- Repeat playback may also be unavailable during P.B.C. playback of VCD.

3-23-1 OSD icons that can be selected with each disc type and mode

[During playback of DVD AUDIO] (DV-5900M only)

 : Repeat playback of the track being played.

 : Repeat playback of the group being played.

 : Repeat playback of the disc being played.

- "Disc" is displayed only when "SEQUENTIAL" indicator is lit.

 : Repeat playback Off.

[During playback of DVD VIDEO]

 : Repeat playback of the chapter being played.

 : Repeat playback of the title being played.

 : Repeat playback Off.

[During playback of CD or VCD]

 : Repeat playback of the track being played.

 : Repeat playback of the disc being played.

 : Repeat playback Off.

[During playback of MP3]

 : Repeat playback of the file being played.

 : Repeat playback of the folder being played.

 : Repeat playback of the disc being played.

 : Repeat playback Off.

[In the program mode]

 : Repeat playback of programmed contents.

 : Repeat playback Off.

[In the random mode]

 : Repeat playback according to the current random play mode.

 : Repeat playback Off.

[In the MUSIC TYPE mode]

→ 56

During play

 : Repeat playback of the track being played.

 : Repeat playback of the disc being played.

 : Repeat playback of music type contents.

 : Repeat playback Off.

During stop

 : Repeat playback of music type contents.

 : Repeat playback Off.

[In the USER FILE mode]

→ 58

During play

 : Repeat playback of the track being played.

 : Repeat playback of the disc being played.

 : Repeat playback of user file contents.

 : Repeat playback Off.

During stop

 : Repeat playback of user file contents.

 : Repeat playback Off.

3-24 Switching the time display

The information in the time display can be switched over. (The information can also be switched by the OSD operation. → [40](#))

This operation is not available in stop mode, during menu playback of DVD or with a DVD for which time display is disabled.

If P.B.C. is set to On with a VCD, set P.B.C. to Off. → [33](#)

Press the **TIME DISPLAY** button during playback to display the **"MAIN"** OSD. Each further press of the button changes the time display icons as shown below.



"Single Time": Elapsed play time of a track, chapter or file.



"Single Remain Time": Remaining time in a track, chapter or file.



"Total Time": Elapsed play time of a disc, group or title.



"Total Remain Time": Remaining time in a disc, group or title.

- If you are operating the remote, press the **TIME** button.
- If the on-screen message or OSD is displayed outside the TV screen when using a widescreen TV or similar monitoring device, set the **"OSD Position"** setting to **"Cinema"**. → [74](#)
- In the program or random play mode, only **"Single Time"** and **"Single Remain Time"** can be switched over.
- With a MP3 file, only the **"Single Time"** information is displayed.

3-25 Pure Audio function (DV-5900M only)

It blocks the video signal to prevent interference between the video and audio signals so pure audio can be reproduced by switching the Pure Audio function On. When the video signal is blocked, the TV screen shows no picture during audio playback.

Press the **PURE AUDIO** button on the remote to switch the Pure Audio function on/off.

- When the Pure Audio function is activated, the **PURE AUDIO** indicator lights up. Pressing the button again switches the Pure Audio function off and turns the indicator off.
- When an operation for displaying the on-screen message (the display of the performed operation contents on the TV screen) or OSD is performed, the video signal is output temporarily.
- With some DVD and VCD discs, the menu may be displayed.

3-26 Switching the audio language

When a VCD or a DVD containing the recording of audio in multiple languages is played, the language used in the voice can be switched over. (The audio language can also be switched by the OSD operation. → [43](#))

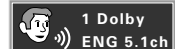
Press the **AUDIO** button during playback to display the **"SOUND"** OSD. Each further press of the button switches the displayed  (Audio icon).





- If the on-screen message or OSD is displayed outside the TV screen when using a widescreen TV or similar monitoring device, set the **"OSD Position"** setting to **"Cinema"**. → [74](#)
- With a DVD AUDIO disc, an audio language number can be selected from up to 2 numbers.
- With a DVD VIDEO disc, an audio language number can be selected from up to 8 numbers.
- With VCD, **"Stereo"**, **"L"**, **"R"** or **"L+R"** can be selected.
- The default audio language set by the user is selected when the power is turned on or the disc is changed. If the default language is not contained in the disc, the priority language defined for the disc will be played back.
- The above operation is not available in stop mode. It is also unavailable with ordinary music CDs (CD-R, CD-RW).

Chapter 4 : OSD Operation

4-1 Introduction

The operations described in this chapter allows the user to perform operations and settings by referring to the OSD (On-Screen Display). As the OSD operation uses only the specific buttons on the remote, the user can enjoy the functions of the player even before memorizing the functions of all buttons.

This chapter is composed of the following sections.

Basic OSD Operation	-  38
"MAIN" OSD Operation	-  39
"SOUND" OSD Operation	-  43
"VISUAL" OSD Operation	-  45

- If the on-screen message or OSD is displayed outside the TV screen when using a widescreen TV or similar monitoring device, set the "**OSD Position**" setting to "**Cinema**". -  74
- The OSD cannot be displayed when DVD is played by menu playback. It may also be unavailable with certain discs.
- The "**SOUND**" OSD and "**VISUAL**" OSD can be displayed only in a play mode.

4-2 Basic OSD Operation

Various operations can be performed by selecting the OSD icons on the TV screen using the cursor button on the remote.

Operation procedure

1. Press the **ON SCREEN** button to display OSD.

"MAIN" OSD :

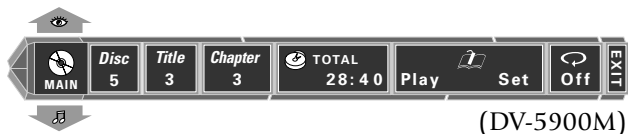

(DV-5900M)

Only the "MAIN" OSD can be displayed when the button is pressed in stop mode. (The up and down arrows shown in the above figure are not displayed.)

When the button is pressed in a play mode, the OSD can be changed by pressing the cursor up/down button.

"SOUND" OSD :

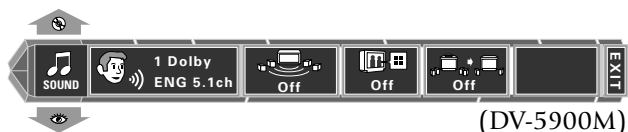

(DV-5900M)

"VISUAL" OSD :

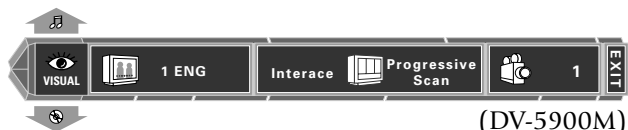

(DV-5900M)

- If the on-screen message or OSD is displayed outside the TV screen when using a widescreen TV or similar monitoring device, set the "OSD Position" setting to "Cinema". → 74

2. Select an OSD icon by pressing the cursor up/down button, then press the **ENTER** button to display the pull-down menu.

- Press the cursor button to move the cursor. But the cursor cannot be moved to the icons of currently unavailable functions.
- The OSD includes icons with a variety of functions. The displayed icons are variable depending on the player status and played disc.
- When the cursor is located on the left or right end, if you attempt to move the cursor toward the outside, the cursor will move to the opposite end.
- To clear the OSD display, move the cursor to the **EXIT** icon and press the **ENTER** button. (The same effect can also be obtained by pressing the **ON SCREEN** button.)

3. From the displayed pull-down menu, select the desired item by pressing cursor button up/down button or by inputting the desired item number using **0 to 9**, **+10** and **+100** button.

Example of pull-down menu display:

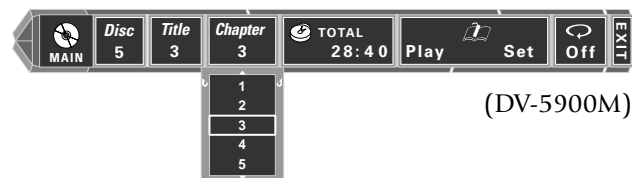

(DV-5900M)

Example of menu display when a number is input:

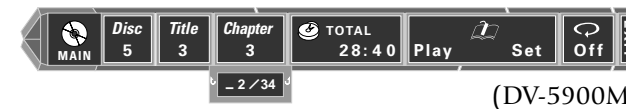

(DV-5900M)

When a group, title, chapter, track, folder, or file number is input using numeric buttons, the pull-down menu display changes and the input number blinks in it. (The figure on the right of the input number shows the number of chapters in the disc.)

If you commit a mistake in the numeric button input, press the **RETURN** button and restart the input from the beginning.

- When ▲ and ▼ are displayed on the top and bottom of the pull-down menu, the menu has more pages above or below the current page. When the cursor is located on the bottom edge, press the cursor down button makes it possible to advance to the next page. (When the cursor is located on the top edge, press the cursor upward makes it possible to return to the previous page.)
- "↵" and "↶" on the left and right edges of pull-down menu indicates that pressing the cursor button makes it possible to clear the pull-down menu and move the cursor to the originally pressed icon. (The same effect is also available by pressing the **RETURN** button.)

4. Press the **ENTER** button to enter the selection in memory.

- The OSD icon display varies depending on the content of change.

4-3 "MAIN" OSD Operation

This section describes the display contents and controllable items of the "MAIN" OSD. (Note that certain items may not be controllable depending on the played disc and player status.)

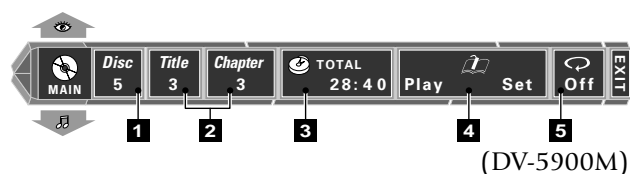

- 1 Disc icon:** Shows the disc number. Select to change the disc. → 40
- 2 Group icon:** Shows the group number in DVD AUDIO disc. (DV-5900M only)
Track icon: Shows the track number in DVD AUDIO, VCD or CD disc.
Title icon: Shows the title number in DVD VIDEO disc.
Chapter icon: Shows the chapter number in DVD VIDEO disc.
Folder icon: Shows the folder number in MP3 file.
File icon: Shows the file number in MP3 file.
 Select an icon to change its content.
- 3 Time display icon:** Shows the disc time. Select to perform time search or change the time display. → 40
- 4 Memory Play/Memory Set icon:** Select to register or recall memory. → 40
- 5 Repeat icon:** Shows the repeat mode. Select to use repeat play mode. → 41

4-3-1 Selecting the disc to be played

Use the following procedure to select a new disc to be played using OSD.

- Rotate the **DISC** knob on the front panel to select the disc number. The disc number can also be selected using the **DISC SEL.** and numeric buttons on the remote.

Operation procedure

1. Press the **ON SCREEN** button to display the "MAIN" OSD.
2. Move the cursor to the  (Disc icon) by pressing the cursor left/right button, then press the **ENTER** button.
 - This operation is not available in the all random and program mode.
3. Select the disc number (1~400, PLUS1~3) by pressing the cursor up/down button, then press the **ENTER** button to start playback.

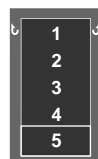

The cursor is displayed on the currently selected disc number.

- The disc number can be selected directly by using the numeric buttons.

4-3-2 Selecting a group, title, folder, chapter, track or file

Use the following procedure to select a new group, title, folder, chapter, track or file to be played using OSD. (They can also be selected directly by pressing the numeric buttons or a **◀▶** button. → 31)

When performing this operation with a P.B.C.-compatible VCD, set P.B.C. to off. → 33

Operation procedure

1. Press the **ON SCREEN** button during playback to display the "MAIN" OSD.
2. Move the cursor to the "**Group**", "**Track**", "**Title**", "**Chapter**", "**Folder**" or "**File**" icon by pressing the cursor left/right button, then press the **ENTER** button.

DVD AUDIO (DV-5900M only) :

Select  or 

DVD VIDEO: Select  or 

CD, VCD : Select 

MP3 : Select  or 

3. Select the number by pressing the cursor up/down button, then press the **ENTER** button to start playback.

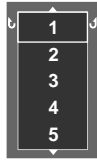

During playback, the cursor is located on the current group, title, folder, chapter, track or file number. (In this figure, the last number can be displayed by pressing the cursor up button.)

The number can also be selected by composing the number with numeric buttons on the remote.

- Only the title or group icon can be selected in stop mode of DVD.

4-3-3 Time display switching and time search

Use the following procedure to switch the type of information shown by the time display shown in the OSD or player display. Time search is also available for specifying the position to start playback by inputting the time information. (The time display information type can also be changed using the **TIME** button.)

Time search is not available in stop mode, during menu playback of a DVD or with a DVD VIDEO which does not provide the time display.

When performing this operation with a P.B.C.-compatible VCD, set P.B.C. to off. → 

- This operation is not available with a MP3 file.

Operation procedure

1. Press the **ON SCREEN** button during playback to display the "**MAIN**" OSD.

2. Move the cursor to  (Time Display icon) by pressing the cursor left/right button, then press the **ENTER** button.

3. Select the type of time display information by pressing the cursor up/down button, then press the **ENTER** button.

If time search is required, move the cursor to the time display icon to select the type of time display information, then perform the operations in step 4.



- In the program or random play mode, only "**Single Time**" and "**Single Remain Time**" can be switched over.
- The time display icon in the OSD and the time display in the player display varies according to the change.
- When "**Total Time**" or "**Total Remain Time**" is selected, the "**TOTAL**" indicator in the display light up.

4. Input the time to start playback using **0** to **9**, then press the **ENTER** button.

Input examples:

1 hr. 05 min. 00 sec. (with a DVD):

1, 0, 5, 0, 0

65 min. 00 sec. (with a CD or VCD):

6, 5, 0, 0

1 min. 28 sec.:

1, 2, 8

- If you commit a mistake in the numeric button input, press the **RETURN** button and restart the input from the beginning.

4-3-4 Memory playback

When you register a scene you like in memory, you can start playback from that scene any time you want. Up to 10 scenes can be registered in memory.

Memory registration and deletion are not available during menu playback of DVD or with a DVD VIDEO for which time display is disabled.

When performing this operation with a P.B.C.-compatible VCD, set P.B.C. to off. → 

- This function may be unavailable with certain discs.
- This operation is not available with a MP3 file.

a : Registering a scene in memory

Operation procedure



1. Press the **ON SCREEN** button during playback to display the "**MAIN**" OSD.

- Move the cursor to  (Memory Set icon) by pressing the cursor button left/right, then press the **ENTER** button.
- Select the memory number to be used in registration by pressing the cursor up/down button, then press the **ENTER** button when the scene to be registered comes.

Disc	Tl/Grp/Trk	Time
1	4 1	0 : 0 8 : 2 8
2	- - -	- : - : - -
3	- - -	- : - : - -
4	- - -	- : - : - -

The memory numbers in which scenes have already been registered show the disc number, title, group, folder, track or file number and the time. Memory numbers 5 to 10 are displayed on the next display page.

- The displayed time value is the accumulated count since second 0 of the first track in the same group. (DVD Audio/DV-5900M only)
- To cancel memory function, press the **RETURN** button.
- Up to 10 scenes can be registered in memory.
- When a number in which a scene has already been registered is selected, the scene will overwrite the existing memory.
- The memory is cleared when the disc is changed or the disc is reversed with the DISC FLIP function.

→  30 →  53

b : Recalling memory

Operation procedure

- Press the **ON SCREEN** button to display the "MAIN" OSD.
- Move the cursor to  (Memory Play icon) and press the **ENTER** button.
- Select the memory number of the scene to be recalled by pressing the cursor up/down button, then press the **ENTER** button.

4-3-5 Repeat playback

(The same effect can also be obtained directly by pressing the **REPEAT** button.)

- This function may be unavailable with certain discs.

Operation procedure

- Press the **ON SCREEN** button during playback to display the "MAIN" OSD.
- Move the cursor to  (Repeat icon) by pressing the cursor left/right button, then press the **ENTER** button.
- Select the repeat mode by pressing the cursor up/down button, then press the **ENTER** button.

- When the repeat mode is changed, the repeat icon varies according to the change. When the player is set to a repeat play mode, the "REPEAT" indicator in the display lights up and the character information display also shows the repeat mode information for a few seconds.
- This operation is not available with a DVD with which the elapsed play time information is not displayed.
- Repeat playback may also sometimes be unavailable during P.B.C. playback of VCD.

a : OSD icons that can be selected with each disc type and mode

[During playback of DVD AUDIO] (DV-5900M only)

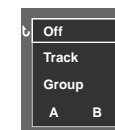

"Off": Repeat playback off.

"Track": Repeat playback of the track being played.

"Group": Repeat playback of the group being played.

"A": A-B repeat playback. → 

- "Disc" is displayed only when "SEQUENTIAL" indicator is lit.

[During playback of DVD VIDEO]

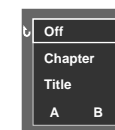

"Off": Repeat playback off.

"Chapter": Repeat playback of the chapter being played.

"Title": Repeat playback of the title being played.

"A": A-B repeat playback. → 

[During playback of CD or VCD]

"Off": Repeat playback off.

"Track": Repeat playback of the track being played.

"Disc": Repeat playback of the disc being played.

"A": A-B repeat playback.

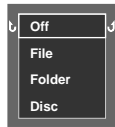
**[During playback of MP3]**

"Off": Repeat playback off.

"File": Repeat playback of the file being played.

"Folder": Repeat playback of the folder being played.

"Disc": Repeat playback of the disc being played.

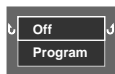
[In the program mode]

"Off": Repeat playback off.

"Program": Repeat playback of programmed contents.

[In the random mode]

"Off": Repeat playback Off.

"Random": Repeat playback according to the current random play mode.

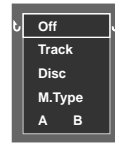
[In the MUSIC TYPE mode]**During playback**

"Off": Repeat playback off.

"Track": Repeat playback of the track being played.

"Disc": Repeat playback of the disc being played.

"M.Type": Repeat playback of music type contents.

"A": A-B repeat playback.

**During stop**

"Off": Repeat playback off.

"M.Type": Repeat playback of music type contents.

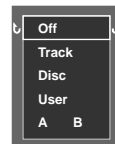
[In the USER FILE mode]**During playback**

"Off": Repeat playback off.

"Track": Repeat playback of the track being played.

"Disc": Repeat playback of the disc being played.

"User": Repeat playback of user file contents.

"A": A-B repeat playback.

**During stop**

"Off": Repeat playback off.

"User": Repeat playback of user file contents.

4-3-6 A-B repeat playback

A-B repeat playback allows you to play a specified section repeatedly.

- This function may be unavailable with certain discs.
- This operation is not available with a MP3 file.

Operation procedure

1. Perform the repeat playback procedure steps 1. and 2.
2. Select "A" by pressing the cursor up/down button, then press the **ENTER** button. The current disc position is stored in memory as point **A** where the repeat playback is to be started and the cursor is moved to "B".
 - The Repeat icon changes to "A" and the "REPEAT" and "A ►" indicators in the display light up.
3. When point **B** where you want to stop repeat playback comes, press the **ENTER** button again. Repeat playback of the section between points **A** and **B** starts.
 - The Repeat icon changes to "A B" and the "REPEAT" and "A ► B" indicators light in the display.
 - To cancel repeat playback, select "Off".
 - This operation is not available during P.B.C. playback of a VCD or with a DVD disc without time display.
 - This operation is not available in the all random and program mode.
 - A-B Repeat playback can be used only within a same title. (DVD Video)
 - A-B Repeat playback can be used only within a same track. (DVD Audio/DV-5900M only)

4-4 "SOUND" OSD Operation

This section describes the items which can be controlled with the "SOUND" OSD. (Some items may be uncontrollable depending on the played disc and player status.)

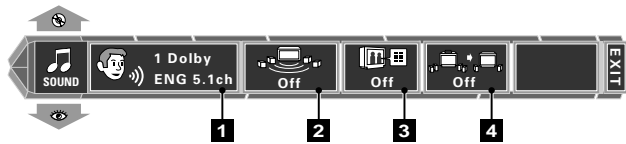

(DV-5900M)

- 1 Audio icon:** Shows the audio signal, audio language and audio language No., number of audio channels. Select to switch the audio language.
- 2 Virtual Surround icon:** Shows the level of the Virtual Surround effect. Select to adjust the level of Virtual Surround or switch it off.
- 3 Cinema voice icon:** Shows the on/off status of Cinema Voice. Select to switch Cinema Voice on or off. → 44
- 4 Down Mix icon (DV-5900M only):** Shows the on/off status of Down mix. Select to switch Down Mix on or off. → 44

4-4-1 Switching the audio language

When a VCD or a DVD containing the recording of audio in multiple languages is played, the language used in the voice can be switched over. (The audio language can also be switched directly by pressing the **AUDIO** button.)

Operation procedure

- 1.** Press the **ON SCREEN** button during DVD playback and select the "SOUND" OSD by pressing the cursor up/down button.
- 2.** Move the cursor to  (Audio icon) by pressing the cursor left/right button, then press the **ENTER** button.
- 3.** Select the desired audio language number by pressing the cursor up/down button, then press the **ENTER** button.
 - With a DVD AUDIO disc, an audio language number can be selected.



- With a DVD VIDEO disc, an audio language number can be selected from up to 8 numbers.
- With VCD, "Stereo", "L", "R" or "L+R" can be selected.
- The default audio language set by the user is selected when the power is turned on or the disc is changed. If the default language is not contained in the disc, the priority language defined for the disc will be played back.

4-4-2 Virtual Surround function

When playing a DVD recorded with Dolby Digital Surround audio, powerful sound can be reproduced even when you use only two speakers.

Operation procedure

- 1.** Press the **ON SCREEN** button during DVD playback, and select the "SOUND" OSD by pressing the cursor up/down button.
- 2.** Move the cursor to  (Virtual Surround icon) by pressing the cursor left/right button, then press the **ENTER** button.
 - The icon can be selected only when the played software is recorded in Dolby Digital audio (with 2 or more channels).
- 3.** Select the level of Virtual Surround effect by pressing the cursor up/down button, then press the **ENTER** button.

DV-5900M

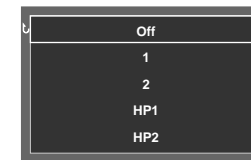

The effect is increased when the selected level is higher. Select "Off" to switch the effect Off. To select the level of the Virtual Surround effect through headphones, select "HP VSS1" or "HP VSS2".

Other

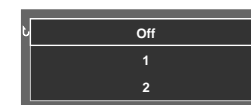

The effect is increased when the selected level is higher. Select "Off" to switch the effect Off.

- When a DVD recorded with Dolby Digital audio (with 2 or more channels) is played, the "**DOLBY DIGITAL**" indicator on the player main unit lights up.

4-4-3 Cinema Voice function

This function to be used when words are hard to be distinguished during playback of DVD recorded with Dolby Digital Surround, Dolby Digital, DTS, or DVD AUDIO* LPCM.

To use this function, it is required that the disc being played provides the center channel audio.

*DVD AUDIO is DV-5900M only

- When the digital output terminal is used, the "**Digital Audio**" setting should be set to "**PCM**" or "**Off**". 

Operation procedure

1. Press the **ON SCREEN** button during playback of DVD, then select the "**SOUND**" OSD by pressing the cursor up/down button.
2. Move the cursor to  (Cinema Voice icon) by pressing the cursor left/right button, then press the **ENTER** button.
 - The icon can be selected only when the played software is recorded with Dolby Digital Surround, Dolby Digital, DTS, or DVD AUDIO* LPCM. (with center channel).
3. Select on or off by pressing the cursor up/down button, then press the **ENTER** button.

4-4-4 Down Mix function (DV-5900M only)

This function is available with a DVD containing the recording of multi-channel audio.

This function converts the multi-channel audio into 2-channel audio and outputs to **6CH OUTPUT L/R** terminals.

Operation procedure

1. Press the **ON SCREEN** button during playback of DVD, then select the "**SOUND**" OSD by pressing the cursor up, down button.
2. Move the cursor to  (Down mix icon) by pressing the cursor left/right button, then press the **ENTER** button.
3. Select on or off by pressing the cursor up/down button, then press the **ENTER** button.

4-5 "VISUAL" OSD Operation

This section describes the items which can be controlled with the "VISUAL" OSD. (Some items may be uncontrollable depending on the played disc and player status.)

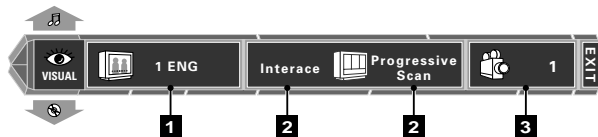

(DV-5900M)

1 Subtitle icon: Shows the language used in subtitles. Select the subtitle language.

DVD AUDIO disc (DV-5900M only)

During playback of a DVD-AUDIO disc containing the recording of still pictures (ASV; Audio Still Video), the Sub-title icon shows the still image display information (display timing, image display sequence, etc.).

2 Visual Mode icon (Interlace, Progressive):
(DV-5900M only)

Shows the current picture quality. Select to adjust the picture quality.

3 Angle icon: Shows the angle number. Select to change the viewing angle. → 47

4-5-1 Switching the subtitle language (8)))

When a DVD contains recording of subtitles in multiple languages, the desired subtitle language can be selected.

Operation procedure

1. Press the **ON SCREEN** button during playback of DVD, and select the "VISUAL" OSD by pressing the cursor up/down button.
2. Move the cursor to  1 ENG (Subtitle icon) by pressing the cursor left/right button, then press the **ENTER** button.
3. Select the desired subtitle language number by pressing the cursor up/down button, then press the **ENTER** button.

- The desired subtitle language number can be selected from up to **32** numbers.
- No subtitle is displayed when "Off" is selected. When the desired language is not included in the options, the language is not recorded in the disc.
- The default subtitle language set by the user is selected when the power is turned on or the disc is changed. If the default language is not contained in the disc, the priority language defined for the disc will be played.

4-5-2 Adjusting the picture quality (DV-5900M only)

Use the following procedure to adjust the picture quality. (If the desired picture quality cannot be obtained by the following operation, adjust it on the TV.)

- The setting items vary depending on the position of the **COMPONENT VIDEO OUTPUT** switch on the rear of the player. → 14

When "INTERLACE" is set
When "PROGRESSIVE" is set

→ 46

a : When "INTERLACE" is set

Operation procedure

1. Press the **ON SCREEN** button during playback, then display the "VISUAL" OSD by pressing the cursor up/down button.
2. Move the cursor to  (Picture quality adjustment icon) by pressing the cursor left/right button, then press the **ENTER** button.
3. Select one of the following picture quality settings by pressing the cursor up/down button, then press the **ENTER** button.



"Normal": Normal picture quality.

"Fine": Sharp picture quality with enhanced contours.

"Soft": Soft picture quality with less noise.

"Cinema": Picture quality close to the images on the movie theater screen.

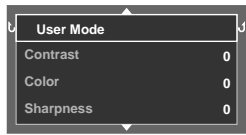

When "User Mode" in the next page is selected, more detailed setting is available. In this case, also perform the operation in step 4.

4. Select a setting item by pressing the cursor up/down button, then press the **ENTER** button.

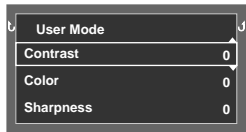

"Contrast": Adjustment of the difference between the bright and dark parts of picture in the range between -7 and +7.

"Color" : Adjustment of the depth of colors in the range between -7 and +7.

"Sharpness": Adjustment of the degree of picture contour enhancement in the range between -2 and +2.

The following setting items are provided on the next page.

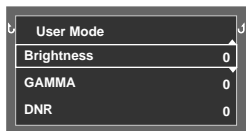

"Brightness": Adjustment of the picture brightness in the range between 0 and +15.

"GAMMA": Adjustment according to the gamma curve of the monitor, in the range between -7 and +7.

"DNR" (Digital Noise Reduction): Adjustment for reducing noise in the picture, in the range between 0 and +15.

5. Select a value by pressing the cursor up/down button, then press the **ENTER** button.

- The picture quality varies according to the selected value. Set the desired picture quality by repeating steps 4 and 5.

b : When "PROGRESSIVE" is set

Operation procedure

1. Press the **ON SCREEN** button during playback, then display the **"VISUAL"** OSD by pressing the cursor up/down button.
2. Move the cursor to  (Picture quality adjustment icon) by pressing the cursor left/right button, then press the **ENTER** button.
3. Select a setting item by pressing the cursor up/down button, then press the **ENTER** button.



"Normal", **"Fine"**, **"Soft"**, **"Cinema"**, → 45

"Animation" : Suitable for viewing pictures composed of vivid colors, such as animation movies.



The following setting items are provided on the next page.

"User Mode"

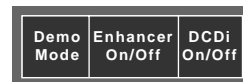

"Demo": When **"Demo"** is selected, **"DCDi"** and **"Enhancer"** will be turned on/off alternately every 15 seconds.

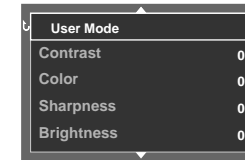

When "User Mode" in the next page is selected, more detailed setting is available. In this case, also perform the operation in step 4.

4. Select a setting item by pressing the cursor up/down button, then press the **ENTER** button.

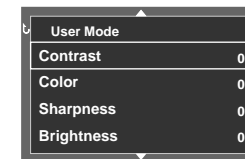

"Contrast" **"Color"** **"Sharpness"** **"Brightness"** → 46

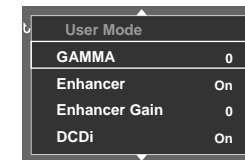

The following setting items are provided on the next page.

"GAMMA" → 46

"Enhancer": Enhancement of image sharpness. On/Off

"Enhancer Gain" : Adjustment of the degree of enhancer in the range between 0 and +15.

"DCDi" : Minimizes jaggies on angled lines. On/Off

5. Select a value by pressing the cursor up/down button, then press the **ENTER** button.

- The picture quality varies according to the selected value. Set the desired picture quality by repeating steps 4 and 5.

4-5-3 Switching the viewing angle ()

When a DVD containing the recording of multiple viewing angles is played, the angles can be switched as desired.

Operation procedure

1. During playback of DVD, ensure that the "ANGLE" indicator in the display is lit.
2. Press the **ON SCREEN** button during playback, then display the "VISUAL" OSD by pressing the cursor up/down.
3. Move the cursor to  (Angle icon) by pressing the cursor left/right button, then press the **ENTER** button.
4. Select the desired angle number by pressing the cursor up/down button, then press the **ENTER** button.
 - With a DVD, a viewing angle number can be selected from up to **9** numbers.

Chapter 5: Applied Operations

5-1 Introduction

This chapter gives descriptions on the special playback operation, character display of TEXT DISC (CD-TEXT or DVD-TEXT) operation.

This chapter is composed of the following sections.

Switching the Play Modes	→ 49
Program Playback	→ 49
Random playback	→ 50
TEXT DISC Operation	→ 51
Daisy chain function	→ 52
Switching the "DVD VIDEO Mode"	→ 53
Playback of Double-Sided DVD	→ 53
Bonus Group	→ 53

5-2 Switching the Play Modes

The play modes of the player include the program mode, disc random mode and all random mode in addition to the track mode for normal playback.

Select the desired play mode and enjoy disc playback in many ways.

Program mode : Desired tracks in a desired disc can be programmed in the desired order.

Random mode : Tracks can be played in a random order.

Disc random mode : Tracks in a desired disc can be played in a random order. → 

All random mode : Tracks in all discs in the stocker can be played in a random order. → 

Track mode : Normal playback in order of tracks. → 

- This function may be unavailable with certain discs.
- Some operations may be restricted depending on the played disc or player status.
- When the played disc is a P.B.C.-compatible VCD, its P.B.C. is on and you want to switch the play mode, stop the player, press the **P.B.C.** button to switch it off. → 

5-3 Program Playback

Use the following procedure to select desired tracks (up to 32 tracks) from different discs and program them in the desired order. (Program playback is not available with DVD VIDEO, MP3)

5-3-1 Registering and playing the program

Operation procedure

1. In stop mode, press the **PGM** button.
 - The "PGM" indicator on the front panel will light up.
2. On the remote control unit, press the **DISC SEL.** button and select the disc number containing the track to be programmed.
 - The disc number can also be selected using the **DISC + (up)/- (down)** button on the remote.
 - The disc number can also be selected by rotating the **DISC** knob on the front panel.
 - Perform every step within 20 seconds after the previous step.
 - It is also possible to enter the disc number alone without selecting a group and/or track number in the program list. In this case, all of the tracks in the disc will be played back.
 - Newly programmed tracks are appended to the end of the existing program.
3. Press the **SET** button.
 - If you commit a mistake in the numeric button input, press the **CLEAR** button and restart the input from the beginning.

4. With a DVD AUDIO, select a group by pressing one of **0** to **9** buttons on the remote.
 - It is also possible to enter the disc number and group number in the program list without selecting a track number. In this case, all of the tracks in the group will be played back.
5. Press the **SET** button.
6. Select a track number with **0** to **9** and **+10** button.
7. Press the **SET** button to enter the track in the program list.
 - Up to **32** tracks can be programmed by repeating steps **2** to **7** for each. No more tracks can be programmed when the display shows "FULL".
8. Press the **▶** button.
 - Tracks will be played in the order they are programmed.
 - When the **◀◀** or **▶▶** button is pressed during playback, the track will be skipped in the direction of the pressed button.

5-3-2 Checking the program

The contents of the existing program can be checked or modified.

Press the **CHECK** button during stop or playback.

- Each time the **CHECK** button is pressed, the program No. and the disc No. are displayed.
- Press each button within 20 seconds after pressing the previous button.

5-3-3 To change a track in the program

Operation procedure

(Enter stop mode before proceeding.)

1. Press the **CHECK** button repeatedly until the program No, to be changed is displayed.
2. Perform steps 2 and 7 of "**Registering and playing the program**" 

5-3-4 Clearing the program

One or all tracks in the existing program can be cleared.

To clear a track from the program list :

Press the **CLEAR** button.

- Each time the **CLEAR** button is pressed, the last track in the program is cleared.

To exit the PGM :

(Enter stop mode before proceeding.)

Press the **PGM** button.

- The unit enters normal play mode (Track mode).

5-4 Random playback

Disc Random Playback

Tracks in a desired disc can be played back in a random order. (Disc random playback is not available with DVD VIDEO, MP3 file.)

All Disc Random Playback

Tracks in all discs in the stocker can be played in a random order. (All random playback is not available with DVD VIDEO, MP3 file.)

- Set the player to stop mode
- If All Disc Random Playback is required, begin the procedure from step 3.

Operation procedure

1. Check that the player is in the normal play (TRACK mode). 
2. The disc number can also be selected using the **DISC SEL.** and numeric buttons on the remote.
 - The disc number can also be selected using the **DISC + (up)/- (down)** button on the remote.
 - The disc number can also be selected by rotating the **DISC** knob on the front panel.
 - The discs in the PLUS1 to PLUS3 slots cannot be played with random playback.
3. Press the **SET** button.
4. Press the **RANDOM** button to select "**ONE RANDOM**".

If All Disc Random Playback for playing tracks in all discs in a random order is required :

Press the **RANDOM** button to select "**ALL RANDOM**".

- When the player enters the random mode, the "**RANDOM**" indicator in the display lights to indicate that the player is in the disc random mode.
- With "**ALL RANDOM**" playback, the discs that cannot be played in a random order, such as the DVD-VIDEO discs and discs containing MP3 files, are skipped and the next disc will be played.

5-4-1 Stopping random playback

Press the **■** button.

- The "**RANDOM**" indicator turns off.

5-5 TEXT DISC Operation

When the played disc is a TEXT DISC (CD-TEXT or DVD-TEXT*), text information recorded in the disc (disc title, verse writer names, composer names, etc.) can be recalled and displayed.

* DVD-TEXT is DV-5900M only

[Display scrolling]

When the amount of character information such as track titles is too large, it cannot be displayed in a single display page. In such a case, the display characters flow from the right to the left to show the previously hidden characters. Such a movement in the display is referred to as <scrolled display>.

5-5-1 Switching the character information

When a TEXT DISC is played, the displayed character information can be switched over.

Each press of **TEXT DISPLAY** displays the character information by scrolling then switches it.

DVD/VCD/CD

Order of information in stop mode :

① **Disc Title*** → ② **Disc Artist*** → ③ **Disc No. Disc Title*** → ④ **Disc No. "STOP"** (DVD disc) → ⑤ **Disc No. Track No.** → ⑥ **Music Type genre** → ⑦ **User File No. or User File Name*** → ① **Disc Title**

*If the disc contains encoded title data or if you have entered title data

⑥MUSIC TYPE mode only

⑦USER FILE mode only

Order of information in play mode:

① **Track (Chapter) Title*** → ② **Disc Artist*** → ③ **Disc No. Disc Title*** → ④ **Disc No. Track (Chapter) No.** → ⑤ **Music Type genre** → ⑥ **User File No. or User File Name*** → ① **Track (Chapter) Title**

*If the disc contains encoded title data or if you have entered title data

⑤MUSIC TYPE mode only

⑥USER FILE mode only

MP3

Order of information in stop mode :

① **Disc Title*** → ② **Disc Artist*** → ③ **Disc No. Disc Title*** → ④ **Disc No. File No.** → ⑤ **Music Type genre** → ⑥ **User File No. or User File Name*** → ① **Disc Title**

*If the disc contains encoded title data or if you have entered title data

⑤MUSIC TYPE mode only

⑥USER FILE mode only

Order of information in play mode :

① **File Title*** → ② **Folder Title*** → ③ **Disc No. Disc Title*** → ④ **Disc No. File No.** → ⑤ **Music Type genre** → ⑥ **User File No. or User File Name*** → ① **File Title**

*If the disc contains encoded title data or if you have entered title data

⑤MUSIC TYPE mode only

⑥USER FILE mode only

- This operation is not available when the FL Mode is set to "FL OFF" by the **DISP.** button. → 23
- When the disc is changed, the information will be re-displayed from ①.

5-6 Daisy Chain function

Up to three changer units can be connected in daisy chain.

This makes it possible to manage up to 1200 discs and play them continuously.

Complete the required connections.



5-6-1 Turning power on

The daisy chain function indicator area of the three changer units display characters "M", "1" and "2" respectively. When the daisy chain is established, the brackets around the displayed characters light as shown below.



If the **MAIN-SUB SWITCH** of two or more units are set to the same position, the daisy chain function indicators of the overlapping units blink.

When the above makes it necessary to change the position of one or two switches, be sure to unplug the power cord of each changer unit from the wall outlet in advance.

The changer units can be remote controlled from a remote.

The changer unit to be remote controlled can be selected as follows.

MAIN button

Press to remote control the changer unit that has been set to the "MAIN" unit.

SUB 1 button

Press to remote control the changer unit that has been set to the "SUB 1" unit.

SUB 2 button

Press to remote control the changer unit that has been set to the "SUB 2" unit.

- The "ACTIVE" indicator of the changer unit that can currently be remote controlled lights up, then its DVD indicator lights.

5-6-2 Features available with daisy chain connection (RELAY PLAY mode)

Discs are played back in order from "MAIN" to "SUB1" and "SUB2".

Up to 1200 discs can be played back continuously.

- DVD-VIDEO discs and the discs in the PLUS1 to PLUS3 slots are not included in RELAY PLAY.

The RELAY PLAY has the following sub-modes.

RANDOM RELAY mode

A track in each of the up to 1200 discs is played back by selecting discs in a random order.

- The DVD-VIDEO discs, discs in the PLUS1 to PLUS3 slots and discs containing MP3 files are skipped and the next disc will be played.

USER FILE RELAY mode

The discs registered as "user file" in the changer units are played back continuously in the normal order.

- The DVD-VIDEO discs and discs in the PLUS1 to PLUS3 slots are skipped and the next disc will be played.

USER FILE RANDOM RELAY mode

The discs registered as "user file" in the changer units are played back in a random order.

- The DVD-VIDEO discs, discs in the PLUS1 to PLUS3 slots and discs containing MP3 files are skipped and the next disc will be played.

5-6-3 Operation procedure

a: RANDOM RELAY mode/USER FILE RELAY mode

(Enter stop mode before proceeding.)

Press the **MAIN** button on the remote so that the "ACTIVE" indicator in the display of the "MAIN" changer unit lights up.

1. Press the **MODE** button.
2. Press the **DISC + (up)/- (down)** button to select "RELAY PLAY", then press the **SET** button.
3. Press the **DISC + (up)/- (down)** button to select "RANDOM" or "USER FILE 1 to USER FILE 8".
 - Register user file. 
4. Press the **SET** button.

b: USER FILE RANDOM RELAY mode

Press the **RANDOM** button during playback in USER FILE RELAY mode.

c: To exit from the RELAY PLAY modes

Press the **MODE** button.

The unit enters normal play mode (Track mode).

5-7 Switching the "DVD VIDEO Mode" (DV-5900M only)

When playing a disc in which DVD VIDEO and DVD AUDIO are mixed, this setting makes it possible to select whether the DVD VIDEO part or DVD AUDIO part is to be played. To reproduce only the DVD VIDEO part, set this item to "On".

At the factory, the player has been set to "Off" with which the DVD AUDIO part is played back.

Setting items

"↶" : Select to return to the previous screen.

"On" : Select to play only the DVD VIDEO part in a DVD VIDEO/DVD AUDIO mixed disc.

"Off" : Select to play only the DVD AUDIO part in a DVD VIDEO/DVD AUDIO mixed disc.

Operation procedure

1. While the player is in stop mode, press the **SET UP** button to display the "MAIN" menu of "SET UP MENU".
2. Press the **ENTER** button to open the setup screen.
3. In the setup screen, select "DVD VIDEO Mode" by Pressing the cursor up/down button and press the **ENTER** button.

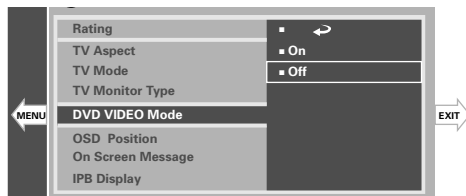

- While a "DVD VIDEO Mode" screen is displayed, pressing the cursor button toward "EXIT" allows the this mode to be canceled and pressing it toward "MENU" returns to the "MENU".

4. Select "On" or "Off" by pressing the cursor up/down button, then press the **ENTER** button to enter the selection in memory.

- This setting is reset to default "Off" when the disc is changed or the power is set to off or standby.

To exit from the "DVD VIDEO mode"

Press the **SET UP** button.

5-8 Playback of Double-Sided DVD

This unit incorporates a one-touch operation facility for reversing the double-sided DVD discs.

"DISC FLIP" is displayed during the disc reversing operation.

During playback of a double-sided DVD disc, the "A" or "B" indicator in the display lights to indicate the side being played.

To reverse the disc :

Press the **DISC FLIP** button.

- This operation is not available when the unit is in a random mode or the program mode.

5-9 Bonus Group (DV-5900M only)

In addition to ordinary groups, some DVD AUDIO discs provide information hidden in a special group as a user service. When this group is selected, the password input screen appears on the TV screen to inform the user of the presence of the bonus group in the disc. The bonus group can be played by inputting the password. (For the registration of password, consult the software producer.)



Input the password using **0** to **9** buttons, then press the **ENTER** button to start playback of the bonus group.

Chapter 6 : Specifying and Using Disc or Track Data

6-1 Introduction

Thanks to sophisticated design and onboard memory storage, your DVD mega-changer can read and store additional information about the discs you load, enabling you to choose discs by title information rather than just disc position.

This memory feature means you don't have to remember what disc is stored in which slot or spend time creating a list of what you've loaded.

Here's how it works: every disc has a Table of Contents code embedded in it. The changer reads this code and associates with it any other information that it reads or that you enter for the disc. It stores the information internally so that when you load or play the disc, the changer still contains the disc and track titles (among other things).

- Your DVD changer will recall information read in at the time of registration even when the disc insertion place is changed.
- Your changer stores this information for up to 420 discs, which allows you to rotate discs between the changer and another CD player without losing any information read.

This chapter is composed of the following sections.

Listening to music by genre	→ 56
Reorganizing discs to desired groups	→ 57
Registration of Title	→ 61
Disc search	→ 64
Searching a desired folder/file by its title	→ 70

6-1-1 The DVD mega-changer can :

- Read data from discs containing encoded CD Text information, DVD Text (DV-5900M only) information
- Store disc and title information you enter using the standard remote, keyboard (DV-5900M only) or LCD remote*
- Allow you to use the read or entered data to select discs.
- Allow you to program disc play for custom listening order.

* **VR-5700, VR-5080/5090, VR-5900** and **KRF-X9995D** (Model available may differ depending on the country and sales area.)
The remote control unit of these receiver models can also be used to input titles or display information such as the titles.

The changer reads any data you specify when you play the disc or when you instruct the changer to read all data.
Your DVD changer includes a standard remote and a keyboard remote. (DV-5900M only)
You can use either device to control the changer. For the sake of simplicity, this manual provides standard remote instructions for all functions except text entry.

You can use this internal processing to control various features, such as :

- Playing discs of a predefined or user-specified Music Type that you can assign to each disc
See “**Listening to music by genre (MUSIC TYPE mode)**” → 56
- Playing discs of a predefined or user-specified User-File that you can assign to each disc
See “**Reorganizing discs to desired groups (USER FILE mode)**” → 57
- Playing discs by selecting disc titles, either read from CD Text, or DVD Text encoding on the disc or entered using the standard remote or keyboard (DV-5900M only)
See “**Disc search (DISC SEARCH mode)**” → 64

6-1-2 Steps of **MODE** button operation
(Procedure flow)

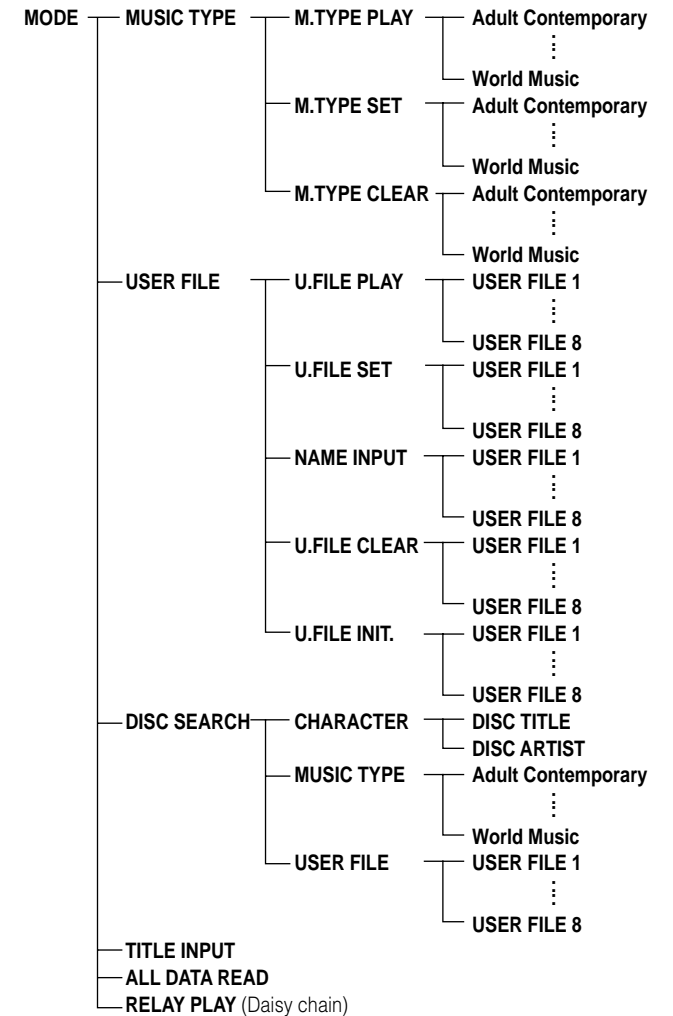

6-2 Listening to music by genre (MUSIC TYPE mode)

Discs can be registered separately by 26 types of music genres.

Adult Contemporary, Alternative Rock, Children's Music, Classical, Contemporary Christian, Country, Dance, Easy Listening, Folk, Gospel, Hip Hop, Jazz, Latin, Musical, New Age, Opera, Operetta, Pop Music, Rap, Reggae, Rock Music, Rhythm & Blues, Sound Effects, Sound Track, Spoken Word, World Music

6-2-1 Registration of music type (MUSIC TYPE SET mode)

Operation procedure

1. Check that the unit is in the normal play TRACK mode. 
 - Make sure that the disc door is closed.
2. Press the **MODE** button.
 - When the **MODE** button is pressed during MUSIC TYPE SET mode, the MUSIC TYPE SET mode is cancelled.
3. Press the **DISC + (up), - (down)** button to select "**MUSIC TYPE**", then press the **SET** button.
4. Press the **DISC + (up), - (down)** button to select "**M.TYPE SET**", then press the **SET** button.
5. Press the **DISC + (up)/- (down)** button to select the music type, and press the **SET** button.

6. Press the **DISC + (up)/- (down)** button to select the disc to be registered in the music type selected in step 5, and press the **SET** button.

- It is not possible to register a single disc number in more than one "music type genre".

If you attempt to register an already registered disc number in a "music type genre", the previous registration of the disc number will be deleted from the previous "music type genre".

- The disc number can also be selected using the numeric buttons. 
- The discs in the PLUS1 to PLUS3 slots cannot be selected.
- Repeat step 6. if it is required to register another disc in the music type selected above.

7. Press the **MODE** button to complete this operation.
 - To register another music type, exit the MUSIC TYPE SET mode once and restart from the beginning.

6-2-2 Playing the music type (MUSIC TYPE PLAY mode)

Operation procedure

1. Check that the unit is in the normal play TRACK mode. 
 - Make sure that the disc door is closed.
2. Press the **MODE** button.
 - When the **MODE** button is pressed during MUSIC TYPE PLAY mode, the MUSIC TYPE PLAY mode is cancelled.

3. Press the **DISC + (up), - (down)** button to select "**MUSIC TYPE**", then press the **SET** button.

4. Press the **DISC + (up), - (down)** button to select "**M.TYPE PLAY**", then press the **SET** button.

- The registered music types are displayed.

5. Press the **DISC + (up)/- (down)** button to select one of the registered "music type" and press the **SET** button.

- If the **RANDOM** button is pressed in this step, random playback will start. (Note that random playback is not available with DVD-VIDEO discs.)

- If repeat playback is required, press the **REPEAT** button.

- To view the discs registered in a "music type", press the **CHECK** button. Each press of the **CHECK** button will display the next disc registered in the "music type".

To exit from MUSIC TYPE PLAY mode

Press the **MODE** button.

The registration can be cleared as follows.

To clear a disc from registration in a "music type":

Play the disc to be registered and press the **CLEAR** button during playback.

6-2-3 To clear the music type (MUSIC TYPE CLEAR mode)

The following procedure clears the registration of one disc in the music type.

Operation procedure

1. Check that the unit is in the normal play TRACK mode. 
 - Make sure that the disc door is closed.
2. Press the **MODE** button.
 - When the **MODE** button is pressed during MUSIC TYPE CLEAR mode, the MUSIC TYPE CLEAR mode is cancelled.
3. Press the **DISC + (up), - (down)** button to select "**MUSIC TYPE**", then press the **SET** button.
4. Press the **DISC + (up), - (down)** button to select "**M.TYPE CLEAR**", then press the **SET** button.
5. Press the **DISC + (up)/- (down)** button to select the music type to be cleared, and press the **SET** button.
6. Press the **DISC + (up)/- (down)** button to select the disc to be cleared, and press the **SET** button.
 - Repeat step 6 as required.
 - When the registration of all "music type genres" is deleted, "**NO ENTRY**" will be displayed.
7. Press the **MODE** button to complete this operation.

6-3 Reorganizing discs to desired groups (USER FILE mode)

Eight user files are available for registering desired discs. This makes the user possible to create files registering the discs of a favorite artist(s) or the user's favorite discs. The user files can be named as desired.

USER FILE 1, USER FILE 2, USER FILE 3, USER FILE 4, USER FILE 5, USER FILE 6, USER FILE 7, USER FILE 8

6-3-1 Registration of user file (USER FILE SET mode)

Operation procedure

1. Check that the unit is in the normal play TRACK mode. 
 - Make sure that the disc door is closed.
2. Press the **MODE** button.
 - When the **MODE** button is pressed during USER FILE SET mode, the USER FILE SET mode is cancelled.
3. Press the **DISC + (up), - (down)** button to select "**USER FILE**", then press the **SET** button.
4. Press the **DISC + (up), - (down)** button to select "**U.FILE SET**", then press the **SET** button.
5. Press the **DISC + (up)/- (down)** button to select a user file number (1 to 8) and press the **SET** button.

- If user file names have already been registered, their names are displayed in place of the above.

"Assigning user file names" 

6. Press the **DISC + (up)/- (down)** button to select the disc to be registered in the "user file" selected in step 5, and press the **SET** button.
 - The disc number can also be selected using the numeric buttons. 
 - The discs in the PLUS1 to PLUS3 slots cannot be selected.
 - Repeat step 6. if it is required to register another disc in the user file selected above.
 - The same disc can be registered in more than one user files.
7. Press the **MODE** button to complete this operation.
 - To register another user file, exit the USER FILE SET mode once and restart from the beginning.

The registration can be cleared as follows.

To clear a disc from registration in a user file:
Play the disc to be registered and press the **CLEAR** button during playback.

To clear all discs registered in a "User File": 

When a "User File" is initialized : 
The file names registered when the "User File Name" is registered are also cleared.

6-3-2 Playing the user file (USER FILE PLAY mode)

Operation procedure

1. Check that the unit is in the normal play TRACK mode. 
 - Make sure that the disc door is closed.
2. Press the **MODE** button.
 - When the **MODE** button is pressed during USER FILE PLAY mode, the USER FILE PLAY mode is cancelled.
3. Press the **DISC + (up), - (down)** button to select "**USER FILE**", then press the **SET** button.
4. Press the **DISC + (up), - (down)** button to select "**U.FILE PLAY**", then press the **SET** button.
5. Press the **DISC + (up)/- (down)** button to select a user file number (1 to 8) and press the **SET** button.

- If user file names have already been registered, their names are displayed.
"**Assigning user file names**" 
- If the **RANDOM** button is pressed in this step, random playback will start.
(Note that random playback is not available with DVD-VIDEO discs.)
- If repeat playback is required, press the **REPEAT** button.

- To view the discs registered in a "user file", press the **CHECK** button. Each press of the **CHECK** button will display the next disc registered in the user file.
- To clear a disc from registration in a "user file", play the disc to be registered and press the **CLEAR** button during playback.

To exit from MUSIC TYPE PLAY mode

Press the **MODE** button.

6-3-3 To clear the user file (USER FILE CLEAR mode)

The following procedure clears the registration of one disc in the user files.

Operation procedure

1. Check that the unit is in the normal play TRACK mode. 
 - Make sure that the disc door is closed.
2. Press the **MODE** button.
 - When the **MODE** button is pressed during USER FILE CLEAR mode, the USER FILE CLEAR mode is cancelled.
3. Press the **DISC + (up), - (down)** button to select "**USER FILE**", then press the **SET** button.
4. Press the **DISC + (up), - (down)** button to select "**U.FILE CLEAR**", then press the **SET** button.

5. Press the **DISC + (up)/- (down)** button to select a user file number (1 to 8) and press the **SET** button.

- If user file names have already been registered, their names are displayed.
"**Assigning user file names**" 

6. Press the **DISC + (up)/- (down)** button to select the disc to be cleared, and press the **SET** button.
 - Repeat step 6 as required.
 - When the registration of all "User File" is deleted, "**NO ENTRY**" will be displayed.
7. Press the **MODE** button to complete this operation.

6-3-4 To initialize the user file (USER FILE INIT. mode)

The following procedure clears the registration of all discs in the user files and the user file names. The user file names return the default names after clear.

Operation procedure

1. Check that the unit is in the normal play TRACK mode. 
 - Make sure that the disc door is closed.
2. Press the **MODE** button.
 - When the **MODE** button is pressed during USER FILE INIT. mode, the USER FILE INIT. mode is cancelled.
3. Press the **DISC + (up), - (down)** button to select "**USER FILE**", then press the **SET** button.

4. Press the **DISC** + (up), - (down) button to select "**U.FILE INIT.**", then press the **SET** button.
5. Press the **DISC** + (up)/- (down) button to select a user file number (1 to 8) and press the **SET** button.
 - If user file names have already been registered, their names are displayed.
 "Assigning user file names" → 59
 - The display on the main unit shows "**FILE INITIAL ?**".
6. Press the **SET** button.
 - The "User file INIT." mode is finished.

6-3-5 Assigning user file names

(FILE NAME INPUT mode)

Although all operations can be controlled from both the standard remote and Keyboard remote control units, do not change the remote control unit in the middle of operation such as character input. Otherwise, characters may not be input correctly. (DV-5900M only)

a : Operation using the standard remote control unit

Operation procedure

1. Check that the unit is in the normal play TRACK mode. → 32
2. Press the **MODE** button.
 - When the **MODE** button is pressed during USER NAME INPUT mode, the FILE NAME INPUT mode is cancelled.
3. Press the **DISC** + (up), - (down) button to select "**USER FILE**", then press the **SET** button.
4. Press the **DISC** + (up), - (down) button to select "**NAME INPUT**", then press the **SET** button.
5. Press the **DISC** + (up), - (down) button to select the user file number you want to assign a file name, and press the **SET** button.

6. Enter the file name using the character input buttons.
 - If a desired character is not provided on the remote control buttons, input the character as follows. Press the **CHARAC.** |◀◀, ▶▶| (down/up) buttons or rotating the **DISC** knob on the main unit until the desired character is displayed in the flashing cursor position. Then, press the **SET** button.
 - The type of characters (capital letters or numbers/symbols) is switched each time the **CHARAC.** button is pressed.
 - A file name can be registered using up to 20 characters.
 - If you commit a mistake in the character button input, press the **DELETE** button and restart the input from the beginning. → 60
 - To enter a space, press the **SPACE** button.
7. Press the **ENTER** button.

To change the character type

Press the **CHARAC.** button repeatedly until the characters of the desired character type are displayed.

■ OVE LIFE+ZAB

Capital letters :

ABC.....XYZ.....

■ OVE LIFE+zab

Small letters :

abc....xyz.....

■ OVE LIFE+9 !

Numbers/symbols :

0 1 2 3.....7 8 9 space ! " # \$
% & ' () * + , - . / : ; < = > ?
@ ^ _ ``

Although all operations can be controlled from both the standard remote and Keyboard remote control units, do not change the remote control unit in the middle of operation such as character input. Otherwise, characters may not be input correctly. (DV-5900M only)

b : Operation using the keyboard remote control unit (DV-5900M only)

Operation procedure

1. Check that the unit is in the normal play TRACK mode. → 32
2. Press the **USER FILE NAME** button.
 - When the **USER FILE NAME** button is pressed during FILE NAME INPUT mode, the FILE NAME INPUT mode is cancelled.
3. Press the **DISC UP**, **DISC DOWN** button to select the user file number you want to assign a title name, and press the **SET** button.
4. Enter the file name using the character input buttons.
 - A file name can be registered using up to 20 characters.
 - If you commit a mistake in the character button input, press the **DELETE** button and restart the input from the beginning. → 60
 - To enter a space, press the **SPACE** button.
5. Press the **ENTER** button.

To change the character type

Holding the **SHIFT** button down, press a character or numeric button.

c : To change a file name

(Standard remote/Keyboard remote)

Operation procedure

1. Make the unit ready for character input.

With the standard remote:

Perform steps 1 to 6 of "Assigning user file names".

→ 59

With the keyboard remote:

Perform steps 1 to 3 of "Assigning user file names".

2. Press the cursor left, right button to move the cursor to the character to be changed.
3. Enter the file name using the character input buttons.
 - No character can be changed if 20 characters have already been input. In this case, delete unnecessary characters then enter the desired correction characters.
 - If the file name to be changed is too long to be displayed on the display section, press the cursor left/right button to scroll the display so that the characters hidden until then appear.
 - A file name can be registered using up to 20 characters.

Standard remote

- If a desired character is not provided on the remote control buttons, input the character as follows. Press the **CHARAC.** |◀◀, ▶▶| (down/up) buttons or rotating the **DISC** knob on the main unit until the desired character is displayed in the flashing cursor position. Then, press the **SET** button.

- The type of characters (capital letters or numbers/symbols) is switched each time the **CHARAC.** button is pressed.

Keyboard remote (DV-5900M only)

- To input a symbol, press and hold the **SHIFT** button while press the desired numeric/symbol button.

4. Press the **ENTER** button.

d : To delete a file name

(Standard remote/Keyboard remote)

Operation procedure

1. Make the unit ready for character input.

With the standard remote:

Perform steps 1 to 6 of "Assigning user file names".

→ 59

With the keyboard remote:

Perform steps 1 to 3 of "Assigning user file names".

2. Press the cursor left, right button to move the cursor to the character to be deleted.
3. Press the **DELETE** button.
4. Press the **ENTER** button.

6-4 Registration of Title

For discs not corresponding to CD-TEXT or DVD-TEXT (DV-5900M only), a title can be given to the disc (max. 20 characters). Up to 20 tracks titles can be registered per disc. Operation is possible also when the disc door is open. We recommend to register titles while discs are being inserted.

6-4-1 Assigning Title (TITLE INPUT mode)

Operation using the standard remote control unit

→ 

Operation using the keyboard remote control unit

→ 

Operation using the OSD

→ 

Although all operations can be controlled from both the standard remote and Keyboard remote control units, do not change the remote control unit in the middle of operation such as character input. Otherwise, characters may not be input correctly. (DV-5900M only)



a : Operation using the standard remote control unit

Operation procedure

To enter the "disc title"

(Enter stop mode before proceeding.)





1. Check that the unit is in the normal play TRACK mode. 
 - Set the player to stop mode.
2. Press the **MODE** button.
 - When the **MODE** button is pressed during TITLE INPUT mode, the TITLE INPUT mode is cancelled.

3. Press the **DISC +** (up), **-** (down) button to select "TITLE INPUT", then press the **SET** button.
4. Press the **DISC +** (up), **-** (down) button to select the disc number that you want to assign a title, and press the **SET** button.
 - The disc number can be selected directly by using the numeric buttons.
5. Enter the title name using the character input buttons.
 - If a desired character is not provided on the remote control buttons, input the character as follows. Press the **CHARAC.**   (down/up) buttons or rotating the **DISC** knob on the main unit until the desired character is displayed in the flashing cursor position. Then, press the **SET** button.
 - The type of characters (capital letters or numbers/symbols) is switched each time the **CHARAC.** button is pressed.
 - A disc title name can be registered using up to 20 characters.
 - For discs corresponding to CD-TEXT or DVD-TEXT (DV-5900M only), a new title can not be registered.
 - If you commit a mistake in the character button input, press the **DELETE** button and restart the input from the beginning. 
 - To enter a space, press the **SPACE** button.
6. Press the **ENTER** button.

To enter the "disc artist"

7. Press the **ENTER** button and repeat steps 5 and 6 for the artist name.
8. Press the **ENTER** button.
 - If you are inputting the title of a MP3 file disc or DVD disc, input the title of the next disc.

To enter the "track title"

9. Press the   button to select the track number.
10. Press the **SET** button.
11. Enter the title name using the character input buttons.
 - If a desired character is not provided on the remote control buttons, input the character as follows. Press the **CHARAC.**   (down/up) buttons or rotating the **DISC** knob on the main unit until the desired character is displayed in the flashing cursor position. Then, press the **SET** button.
 - The type of characters (capital letters or numbers/symbols) is switched each time the **CHARAC.** button is pressed.
 - A track title can be registered using up to 20 characters.
 - Repeat this to enter the track title.
 - If you commit a mistake in the character button input, press the **DELETE** button and restart the input from the beginning. 
 - To enter a space, press the **SPACE** button.
12. Press the **ENTER** button.
 - The unit stands by for the title input for the next track.
 - Repeat steps 9 to 12 as required.
 - When the "track title input" for the last track in the disc has completed, the title input of the next disc starts.

To quit TITLE INPUT mode

Press the **MODE** button.

To change the character type

Press the **CHARAC.** button repeatedly until the characters of the desired character type are displayed.

■ OVE LIFE+zAB

Capital letters :

ABC.....XYZ.....

■ OVE LIFE+zab

Small letters :

abc.....xyz.....

■ OVE LIFE+9 !

Numbers/symbols :

0 1 2 3.....7 8 9 space ! " # \$
% & ' () * + , - . / : ; < = > ?
@ ^ _ `

b : Operation using the keyboard remote control unit

Although all operations can be controlled from both the standard remote and Keyboard remote control units, do not change the remote control unit in the middle of operation such as character input. Otherwise, characters may not be input correctly. (DV-5900M only)

Operation procedure**To enter the "disc title"**

(Enter stop mode before proceeding.)

1. Check that the unit is in the normal play TRACK mode. →  32
 - Set the player to stop mode.
2. Press the **TITLE INPUT** button.
 - When the **TITLE INPUT** button is pressed during TITLE INPUT mode, the TITLE INPUT mode is cancelled.

3. Press the **DISC UP, DOWN** button to select the disc number that you want to assign a title, and press the **SET** button.

4. Enter the title name using the character input buttons.

- A disc title name can be registered using up to 20 characters.
- For discs corresponding to CD-TEXT or DVD-TEXT (DV-5900M only), a new title can not be registered.
- If you commit a mistake in the character button input, press the **DELETE** button and restart the input from the beginning. →  60
- To enter a space, press the **SPACE** button.

5. Press the **ENTER** button.

To enter the "disc artist"

6. Press the **ENTER** button and repeat steps 4 and 5 for the artist name.

7. Press the **ENTER** button.

- If you are inputting the title of a MP3 file disc or DVD disc, input the title of the next disc.

To enter the "track title"

8. Press the **◀◀, ▶▶** button to select the track number.
9. Press the **SET** button.

10. Enter the title name using the character input buttons.

- A track title can be registered using up to 20 characters.
- Repeat this to enter the track title.
- If you commit a mistake in the character button input, press the **DELETE** button and restart the input from the beginning. →  60
- To enter a space, press the **SPACE** button.

To change the character type

Holding the **SHIFT** button down, press a character or numeric button.

11. Press the **ENTER** button.

- The unit stands by for the title input for the next track.
- Repeat steps 8 to 11, if you required.
- When the "track title input" for the last track in the disc has completed, the title input of the next disc starts.

To exit from the TITLE INPUT mode

Press the **TITLE INPUT** button.

c : To change a title

(Standard remote/Keyboard remote)

Operation procedure

1. Make the unit ready for character input.

With the standard remote:Perform steps **1 to 5** of "Assigning Title". → **With the keyboard remote:**Perform steps **1 to 4** of "Assigning Title". → 

2. Press the cursor left, right button to move the cursor to the character to be changed.

3. Enter the title name using the character input buttons.

- No character can be changed if 20 characters have already been input. In this case, delete unnecessary characters then enter the desired correction characters.
- If the title to be changed is too long to be displayed on the display section, press the cursor left/right button to scroll the display so that the characters hidden until then appear.
- A title name can be registered using up to 20 characters.
- If you commit a mistake in the character button input, press the **DELETE** button and restart the input from the beginning.

Standard remote

- If a desired character is not provided on the remote control buttons, input the character as follows. Press the **CHARAC.** |◀◀, ▶▶| (down/up) buttons or rotating the **DISC** knob on the main unit until the desired character is displayed in the flashing cursor position. Then, press the **SET** button.

- The type of characters (capital letters or numbers/symbols) is switched each time the **CHARAC.** button is pressed.

Keyboard remote (DV-5900M only)

- To input a symbol, press and hold the **SHIFT** button while press the desired numeric/symbol button.

4. Press the **ENTER** button.

d : To delete a title

(Standard remote/Keyboard remote)

Operation procedure

1. Make the unit ready for character input.

With the standard remote:Perform steps **1 to 5** of "Assigning Title". → **With the keyboard remote:**Perform steps **1 to 4** of "Assigning Title". → 

2. Press the cursor left, right button to move the cursor to the character to be deleted.

3. Press the **DELETE** button.

4. Press the **ENTER** button.

6-5 Disc search (DISC SEARCH mode)

The convenient disc search function searches the desired disc in the changer for playback or ejection.

When daisy chain connection is set, disc search covers all of the discs in the set changer units.

“CHARACTER SEARCH”

Disc search based on the title name or artist name.

Remote control operation →  64
OSD operation →  66

“MUSIC TYPE SEARCH”

Disc search among the discs registered in a music type.

Remote control operation →  65
OSD operation →  67

“USER FILE SEARCH”



Disc search among the discs registered in a user file.

Remote control operation →  66
OSD operation →  68

6-5-1 Disc search using the remote control unit

a : Searching a disc by the disc title (CHARACTER SEARCH mode)

By inputting the initial letter of the desired disc title or artist name, discs which have the disc titles or the artist name beginning with that character can be searched in sequence.

- Check that the unit is in the normal play TRACK mode. →  32
- Input the title. →  61

Operation procedure

1. Press the **MODE** button.
 - When the **MODE** button is pressed during CHARACTER SEARCH mode, the CHARACTER SEARCH mode is cancelled.
2. Press the **DISC** + (up), - (down) button to select “**DISC SEARCH**”, then press the **SET** button.
3. Press the **DISC** + (up), - (down) button to select “**CHARACTER**”, then press the **SET** button.
4. Press the **DISC** + (up), - (down) button to select “**DISC TITLE**” or “**DISC ARTIST**”, then press the **SET** button.

DISC TITLE

Disc search by the initial letters of disc title names.

DISC ARTIST

Disc search by the artist names.

5. Input the initial letter of the disc title or the disc artist to be searched.

- The initial letters of disc titles or disc artist are searched insensitively to the uppercase and lowercase.
- Lowercase characters cannot be input in the CHARACTER SEARCH mode.
- The disc titles or the disc artist beginning the specified character will be scrolled in the display.
- If a desired character is not provided on the remote control buttons, input the character as follows. Press the **CHARAC.** |◀◀, ▶▶| (down/up) buttons or rotating the **DISC** knob on the main unit until the desired character is displayed in the flashing cursor position. Then, press the **SET** button.
- The type of characters (capital letters or numbers/symbols) is switched each time the **CHARAC.** button is pressed.

6. Press the **SET** button.

- If there is no disc registered in the specified character, “**NO ENTRY**” will be displayed.
- When daisy chain connection is set, the set changer units can be switched using the **MAIN**, **SUB 1** and **SUB 2** buttons.

7. Select one of the following operations for the search target disc.

To search the next disc

Press the **DISC +** (up), – (down) button.

To play the searched disc

Press the **SET** button or the ► button.

To eject the searched disc

Press the ▲ **EJECT** button.

b : Searching the music type

(MUSIC TYPE SEARCH mode)

The discs registered in the specified music type can be searched in sequence.

- Check that the unit is in the normal play **TRACK** mode. → 32
- Register music type. → 56

Operation procedure

1. Press the **MODE** button.
 - When the **MODE** button is pressed during **MUSIC TYPE SEARCH** mode, the **MUSIC TYPE SEARCH** mode is cancelled.
2. Press the **DISC +** (up), – (down) button to select “**DISC SEARCH**”, then press the **SET** button.
3. Press the **DISC +** (up), – (down) button to select “**MUSIC TYPE**”, then press the **SET** button.
4. Press the **DISC +** (up), – (down) button to select the music type to be searched.
 - Discs can be registered separately by 26 types of music genres.
 Adult Contemporary, Alternative Rock, Children’sMusic, Classical, Contemporary Christian, Country, Dance, Easy Listening, Folk, Gospel, Hip Hop, Jazz, Latin, Musical, New Age, Opera, Operetta, Pop Music, Rap, Reggae, Rock Music, Rhythm & Blues, Sound Effects, Sound Track, Spoken Word, World Music
 - The registered music types are displayed.

5. Press the **SET** button.
 - If there is no disc registered in the specified music type, “**NO ENTRY**” will be displayed.
 - When daisy chain connection is set, the set changer units can be switched using the **MAIN**, **SUB 1** and **SUB 2** buttons.

6. Select one of the following operations for the search target disc.

To search the next disc

Press the **DISC +** (up), – (down) button.

To play the searched disc

Press the **SET** button or the ► button.

To eject the searched disc

Press the ▲ **EJECT** button.

Disc search can be activated using the buttons on the main unit. (MUSIC TYPE SEARCH mode)

Operation procedure

1. Set the player to stop mode.
2. Press the **MUSIC TYPE** button.
3. Turn the **DISC** knob to select the “music type” to be searched.
4. Press the **SET** button.

C : Searching the user file**(USER FILE SEARCH mode)**

The discs registered in the or specified user file can be searched in sequence.

- Check that the unit is in the normal play TRACK mode. → 32
- Register user file. → 57

Operation procedure

1. Press the **MODE** button.
 - When the **MODE** button is pressed during USER FILE SEARCH mode, the USER FILE SEARCH mode is cancelled.
2. Press the **DISC + (up), - (down)** button to select "**DISC SEARCH**", then press the **SET** button.
3. Press the **DISC + (up), - (down)** button to select "**USER FILE**", then press the **SET** button.
4. Press the **DISC + (up), - (down)** button to select the user file to be searched.

- If user file names have already been registered, their names are displayed in place of the above.

"Assigning user file names" → 59

- When daisy chain connection is set, the set changer units can be switched using the **MAIN, SUB 1** and **SUB 2** buttons.

5. Press the **SET** button.

6. Select one of the following operations for the search target disc.

To search the next disc

Press the **DISC + (up), - (down)** button.

To play the searched disc

Press the **SET** button or the ► button.

To eject the searched disc

Press the ▲ **EJECT** button.

Disc search can be activated using the buttons on the main unit. (USER FILE SEARCH mode)

Operation procedure

1. Set the player to stop mode.
2. Press the **USER FILE** button.
3. Turn the **DISC** knob to select the "User File" to be searched.
4. Press the **SET** button.

6-5-2 Disc search using the OSD

Disc search using the OSD allows the disc title or artist name characters of the target disc to be specified.

a : Searching a disc by the disc title**(CHARACTER SEARCH mode)**

By inputting the initial letter of the desired disc title or artist name, discs which have the disc titles or the artist name beginning with that character can be searched in sequence.

- Check that the unit is in the normal play TRACK mode. → 32
- Input the title. → 61

Operation procedure

(Enter stop mode before proceeding.)

1. Press the **LIBRARY** button.

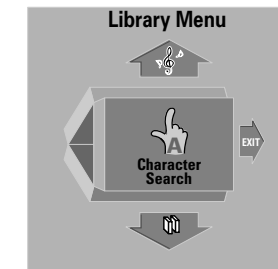

- When the **LIBRARY** button is pressed during CHARACTER SEARCH mode, the CHARACTER SEARCH mode is cancelled.

2. Press the cursor up/down button to select "**Character Search**", then press the **ENTER** button.

3. Press the cursor left/right button to select “Disc” or “Artist”.

Disc

Disc search by the initial letters of disc title names.

Artist

Disc search by the artist names.

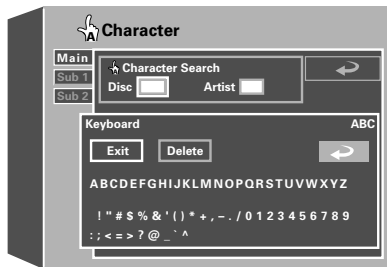

4. Press the cursor button to move the cursor on the OSD screen to the “Keyboard” area, then move the cursor on the desired character and press the ENTER button.

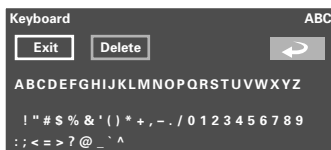

“**↵**” + **ENTER** The search mode is started.



- If you are operating the main unit, press the **RETURN** button.

“**Delete**” + **ENTER** Delete a character.

- If you are operating the remote, select the initial letter with a character input button and press the **ENTER** button.
- Each press of the **CHARAC.** button switches the “character input” and “numeric input” alternately.

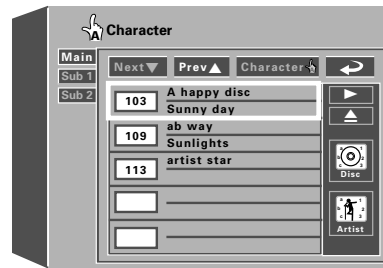
5. Press the cursor button to select “Exit”, then press the **ENTER** button.



- The discs corresponding the selected condition are displayed.
 - The initial letters of disc titles or artist name are searched insensitively to the uppercase and lowercase.
 - Lowercase characters cannot be input in the CHARACTER SEARCH mode.
6. Press the cursor up, down button to select the desired disc and press the **ENTER** button.
- When daisy chain connection is set, the set changer units can be switched using the **MAIN**, **SUB 1** and **SUB 2** buttons.
7. Press the cursor up, down button to select the operation to be performed for the search target disc and press the **ENTER** button.
- “**▶**” Play the searched disc.
- “**▲**” Eject the searched disc.
- “” Input the disc title for the searched disc.
- “” Input the artist name for the searched disc.
- To input the character using OSD → 



To quit CHARACTER SEARCH mode

Press the **LIBRARY** button.

b : Searching the music type

(MUSIC TYPE SEARCH mode)

The discs registered in the specified music type can be searched in sequence.

- Check that the unit is in the normal play TRACK mode. → 
- Register music type. → 

Operation procedure

(Enter stop mode before proceeding.)

1. Press the **LIBRARY** button.

- When the **LIBRARY** button is pressed during MUSIC TYPE SEARCH mode, the MUSIC TYPE SEARCH mode is cancelled.

2. Press the cursor up, down button to select “Music Type Search”, then press the **ENTER** button.

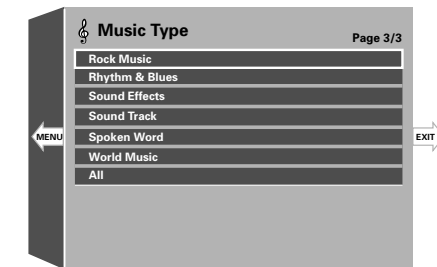

“**All**” This allows you to view all of the discs registered in all of the “Music Type” registered in this unit.

- While a “Disc search” screen is displayed, pressing the cursor button toward “**EXIT**” allows the this mode to be canceled and pressing it toward “**MENU**” returns to the “MENU”.

- Press the cursor up, down button to select the desired music type and press the **ENTER** button.
- Press the cursor up, down button to select the desired disc and press the **ENTER** button.

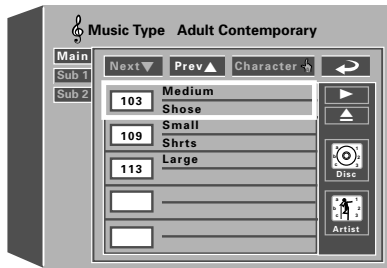

- When ▲ and ▼ are displayed on the top, the menu has more pages above or below the current page. When the cursor is located on the bottom edge, pressing the cursor down button makes it possible to advance to the next page. (When the cursor is located on the top edge, pressing the cursor up button makes it possible to return to the previous page.)
- Place the cursor on the "Character" button on the upper part of the OSD and press the **ENTER** button to start character search of the discs registered in the selected "music type".
- When daisy chain connection is set, the set changer units can be switched using the **MAIN**, **SUB 1** and **SUB 2** buttons.

- Press the cursor up, down button to select the operation to be performed for the search target disc and press the **ENTER** button.

"▶" Play the searched disc.

"▲" Eject the searched disc.

"Disc" Input the disc title for the searched disc.

"Artist" Input the artist name for the searched disc.

- To input the character using OSD → 69
- It is not possible to add or clear registration using the OSD.

To quit MUSIC TYPE SEARCH mode

Press the **LIBRARY** button.

c : Searching the user file

(USER FILE SEARCH mode)

The discs registered in the or specified user file can be searched in sequence.

- Check that the unit is in the normal play TRACK mode. → 32
- Register user file. → 57

Operation procedure

(Enter stop mode before proceeding.)

- Press the **LIBRARY** button.
 - When the **LIBRARY** button is pressed during USER FILE SEARCH mode, the USER FILE SEARCH mode is cancelled.
- Press the cursor up, down button to select "User File Search", then press the **ENTER** button.

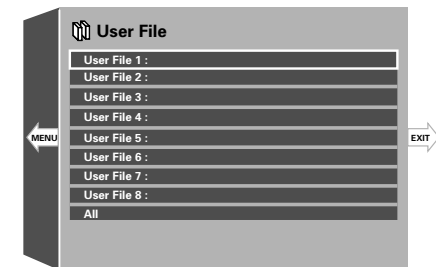

"All" This allows you to view all of the discs registered in all of the "User Files" registered in this unit.

- While a "Disc search" screen is displayed, pressing the cursor button toward "EXIT" allows the this mode to be canceled and pressing it toward "MENU" returns to the "MENU".

3. Press the cursor up, down button to select the desired user file and press the **ENTER** button.
 - The discs corresponding the selected condition are displayed.
 - If user file names have already been registered, their names are displayed.

“Assigning user file names” → 59

4. Press the cursor up, down button to select the desired disc and press the **ENTER** button.

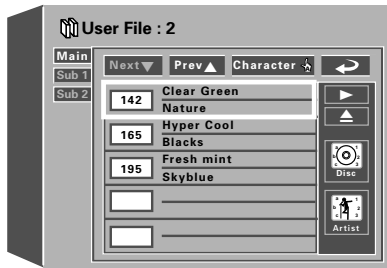

- When ▲ and ▼ are displayed on the top, the menu has more pages above or below the current page. When the cursor is located on the bottom edge, pressing the cursor down button makes it possible to advance to the next page. (When the cursor is located on the top edge, pressing the cursor up button makes it possible to return to the previous page.)
- Place the cursor on the “Character” button on the upper part of the OSD and press the **ENTER** button to start character search of the discs registered in the selected “user file”.
- When daisy chain connection is set, the set changer units can be switched using the **MAIN**, **SUB 1** and **SUB 2** buttons.

5. Press the cursor up, down button to select the operation to be performed for the search target disc and press the **ENTER** button.

“▶” Play the searched disc.

“▲” Eject the searched disc.

“Disc” Input the disc title for the searched disc.

“Artist” Input the artist name for the searched disc.

● To input the character using OSD → 69

- It is not possible to add or clear registration using the OSD.

To quit USER FILE SEARCH mode
Press the **LIBRARY** button.

d : To input the character using OSD

To input the character

- For discs corresponding to CD-TEXT or DVD-TEXT (DV-5900M only), a new title can not be registered.

Operation procedure

1. Makes sure that the disc is selected using the search function.

“CHARACTER SEARCH” step 1 to 6 → 66

“MUSIC TYPE SEARCH” step 1 to 4 → 67

“USER FILE SEARCH” step 1 to 4 → 68

Screen display showing that a disc is selected

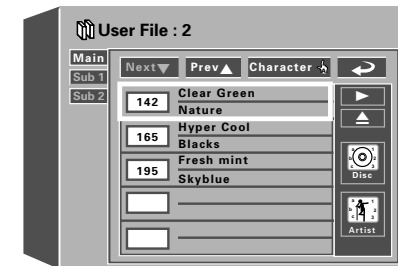

2. Press the cursor up/down button to select “Disc” or “Artist” and press the **ENTER** button.

3. Press the cursor button to move the cursor on the OSD screen to the “Keyboard” area, then move the cursor on the desired character and press the **ENTER** button.



“↵” + **ENTER** Return to the display before the character input.

- If you are operating the main unit, press the **RETURN** button.

“Exit” + **ENTER** Enter the selected character.

“Delete” + **ENTER** Delete the selected character.

“All Clear” + **ENTER** .. Clear all characters in the character display.

- The input character is shown in the character display area at the upper part of the OSD.
- To enter a space, press the **SPACE** button.
- The cursor on the OSD can be moved alternately between the character display area and “**keyboard**” area by pressing the cursor up, down button.
- A file name can be registered using up to 20 characters.

4. Input other characters by repeating step 3 for each.

- Press the **LIBRARY** button to complete this operation.

To change or delete a charater

- For discs corresponding to CD-TEXT or DVD-TEXT (DV-5900M only), a new title can not be registered.

Operation procedure

1. Press the cursor button to move the cursor in the character display area at the upper part of the OSD.
2. Press the cursor left, right button to place the cursor on the character to be displayed.
3. Correct the character.

Correction by replacement with new character :
Press the cursor button to select the new character from the “**Keyboard**” area and press the **ENTER** button.

Correction by deleting a character:
Press the cursor button to select the “**Delete**” button and press the **ENTER** button.

Disc search operation using the main unit buttons

Disc search can be activated using the buttons on the main unit.

- If you are operating the main unit, press the **MUSIC TYPE** or **USER FILE** button and begin the following procedure with step 3.

Operation procedure (main unit)

1. Press the **LIBRARY** button.
(Enter stop mode before proceeding.)

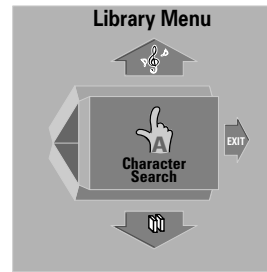

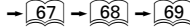
2. Turn the **DISC** knob to select the desired search mode and press the **ENTER** button.
 - The TV screen shows the same OSD information as that displayed when disc search is performed using the remote. 
3. Move the cursor using the main unit buttons and advance operation.

The OSD can be controlled from the main unit as described below.

DISC knob Used to move the cursor upward or downward.

◀◀, ▶▶ button Used to move the cursor to the left or right.

▶ (**ENTER**) button To enter the selected item.

RETURN button Return.

6-6 Searching a desired folder/file by its title (FOLDER/FILE SEARCH mode)

MP3 files can be searched based on the title of the file or the folder containing the file.

- The maximum number of folders or files that can be searched is 999. Folders or files exceeding this number cannot be searched.

Operation procedure

1. Press the **FOLDER SEARCH** button.
 - If file search is required, press the **FILE SEARCH** button instead.
2. Press the cursor up, down button to select the title of the desired folder or file.

3. Press the **ENTER** button.

- In folder search, playback begins with the file with the minimum file number in the searched folder.
- In file search, playback begins with the searched file.

Chapter 7 : Various Setups

7-1 Introduction

This chapter describes the setup operations of the player according to the connected components. Most of the operations described below can be performed using the provided standard remote control unit.

This chapter is composed of the following sections.

Basic Operations in Setup Screen	→ 72
"MAIN" Setting	→ 73
"SOUND" Setting	→ 76
"VISUAL" Setting	→ 82

7-2 Basic Operations in Setup Screen

The "**SET UP MENU**" includes the "**MAIN**", "**SOUND**" and "**VISUAL**" menus. When a setup screen is displayed, select the desired item according to the purpose.

If the power is turned off while the setup screen remains displayed after setting changes, the changes will be invalid. Be sure to close the setup screen before turning power off.

Operation procedure

1. Press the **SET UP** button to open the "**SET UP MENU**" in which "**MAIN**" is displayed.

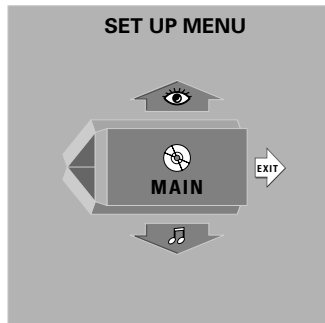

Press the cursor up, down button to switch the displayed menu name to "**SOUND**" or "**VISUAL**".

- When you press the **RETURN** button or press the cursor button in the direction of arrow "**EXIT**" while the "**SET UP MENU**" screen is displayed, the setup mode can be canceled.

2. Press the **ENTER** button to open the setup screen.
 - While a setup screen is displayed, pressing the cursor button toward "**EXIT**" allows the setup mode to be canceled and pressing it toward "**MENU**" returns to the "**SET UP MENU**".
3. Select the desired item by pressing the cursor button in the required direction, then press the **ENTER** button to open the setup change screen.
4. Select a setting by pressing the cursor button in the required direction and press the **ENTER** button to enter the change in memory.
 - Press the **RETURN** button or press the cursor left button to return to the setup screen.

7-3 "MAIN" Setting

7-3-1 When "MAIN" is selected in "SET UP MENU":

The setups according to the connected TV, viewing restriction, DVD VIDEO mode, OSD position, on-screen messages and IPB display can be set.

Operation procedure

1. While the player is in stop mode, press the **SET UP** button to display the "MAIN" menu of "SET UP MENU".
2. Press the **ENTER** button to open the setup screen.

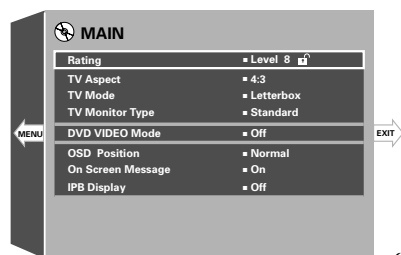

(DV-5900M)

3. In the setup menu, select the Function Item (refer to Right Table) by pressing the cursor up or down button and press the **ENTER** button.
4. Select the Setting Item (refer to Right Table) by pressing the cursor up or down button, then press the **ENTER** button to enter the selection in memory.

- "↶" : Select to return to the previous screen.

Table : SET UP MENU "MAIN" Function & Setting (1/2)

Function Item		Setting Item		Initial Position	
Icon	Function	Icon	Means	DV-5900M	Other
Rating	Sets the viewing restriction of DVD VIDEO. (This functions only with DVD VIDEO discs compatible with viewing restriction.)	0 to 8 Change password Temporary Unlocked		8	←
TV Aspect	Sets the picture aspect ratio according to that of the connected TV.	4 : 3		4 : 3	←
		16 : 9			
TV Mode	Setting is required when Wide screen software is played with the conventional TV (aspect ratio 4:3).	Pan & Scan	Wide screen Video software is played in Pan & Scan style (The picture is shown with either one or both sides cut off). Widescreen Video software w/o Pan & Scan specification will be played in Letterbox style.	Letterbox	←
		Letterbox	Wide screen Video software is played in Letterbox style (black bands appear at the top and bottom of the screen).		
TV Monitor Type (DV-5900M only)	Set this item according to the format of the connected TV or video monitor.	Standard	The CRT-based TV. Usually select this item.	Standard	-
		CRT Projector	The 3-tube front projector.		
		LCD Projector	The LCD front projector.		
		Projection TV	The projection TV.		
		PDP	The plasma display panel.		

Operation procedure

1. While the player is in stop mode, press the **SET UP** button to display the "MAIN" menu of "SET UP MENU".
2. Press the **ENTER** button to open the setup screen.

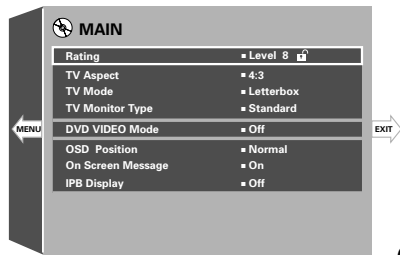

(DV-5900M)

3. In the setup menu, select the Function Item (refer to Right Table) by pressing the cursor up or down button and press the **ENTER** button.
4. Select the Setting Item (refer to Right Table) by pressing the cursor up or down button, then press the **ENTER** button to enter the selection in memory.

● "↶" : Select to return to the previous screen.

Table : SET UP MENU "MAIN" Function & Setting (2/2)

Function Item		Setting Item		Initial Position	
Icon	Function	Icon	Means	DV-5900M	Other
DVD VIDEO Mode (DV-5900M only)	Sets the play mode of DVD discs. Select to play only the DVD VIDEO part in a DVD VIDEO/DVD AUDIO mixed disc. Select to play only the DVD AUDIO part in a DVD VIDEO/DVD AUDIO mixed disc.	On		Off	-
		Off	This setting is reset to default "Off" when the disc is changed or the power is set to off or standby.		
OSD Position	Sets the position of the OSD (On-Screen Display).	Normal	Select to display the OSD and messages on the top of the TV screen. Usually select this setting.	Normal	←
		Cinema	Select to display the OSD and messages on the lower part of the TV screen. Select this setting when the OSD or messages are deviated outside the TV screen.		
On Screen Message	Switches the on-screen message on/off.	On	Select to display on-screen messages.	On	←
		Off	Select to not to display on-screen messages.		
IPB Display	Switches the IPB display on/off.	On	Select to view the IPB display.	Off	←
		Off	Select to not to view the IPB display.		

7-3-2 "Rating" Setting

This setting makes it possible to inhibit the playback of adult DVD videodiscs that you do not want the children to view. However, there are some discs which carries an X-rating indication on the jacket but do not contain recording of the viewing restriction label. With such discs, the viewing restriction of the player is invalid and playback cannot be inhibited.

The default setting is "**Level 8**" which means no restriction. When you change the restriction level for the first time, you will also be requested to register a password.

Setting items

"8 No Limit" : Select to enable playback of any DVD discs whether their targets are adults, general public or children.

"7" to "1": When DVD software containing the recording of restriction level (an adult-oriented disc or a disc including violence), playback is restricted in accordance with the restriction level.

"0 Lock All": Select to inhibit any DVD. Use this setting for example when you want to inhibit playback of an adult-oriented DVD which does not contain the restriction information.

"Change Password": Select to change the viewing restriction password which has been registered before. (This item cannot be selected unless a password has already been registered.)

"Temporary Unlocked": Select to disable temporarily the viewing restriction which has been set previously. (This item cannot be selected unless a password has been set previously.)

7-3-3 Input of Password

When no password has been set previously:

- ① The password input screen as shown below appears. Now compose the password using the numeric buttons and press the **ENTER** button on the remote.

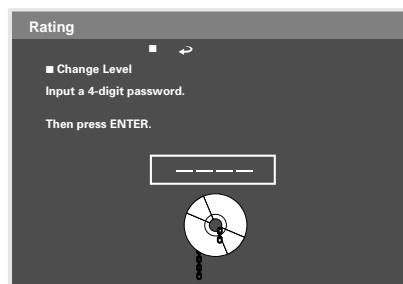

- When "**↔**" in the screen is selected and the **ENTER** button is pressed, the display returns to the setting screen. (This effect can also be achieved by pressing the **RETURN** button.)

- ② The password input screen changes to the confirmation screen, and the input password is shown on the TV screen.

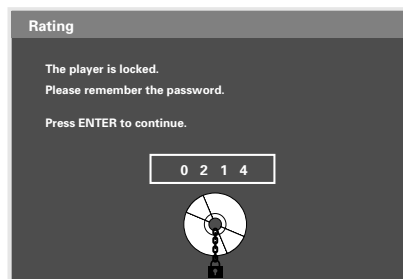

- ③ Note the password in a memo and retain it in a safe place before pressing the **ENTER** button. The password is required when setting the viewing restriction.

When a password has already been set:

The password input screen as shown below appears. Now input the password using the numeric buttons and press the **ENTER** button on the remote.

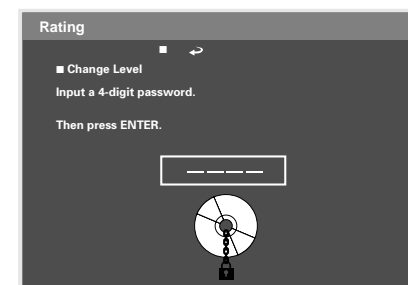

- When "**↔**" in the screen is selected and the **ENTER** button is pressed, the display returns to the setting screen. (This effect can also be achieved by pressing the **RETURN** button.)

If you select "**Change Password**", the screen for input of the new password will open. Input the new password using the numeric buttons and press the **ENTER** button. When the password confirmation screen appears, note the password in a memo and retain it in a safe place then pressing the **ENTER** button.

7-4 "SOUND" Setting

7-4-1 When "SOUND" is selected in "SET UP MENU":

"SOUND" is to be selected when you want to set the audio output method when system components are connected using the digital audio output connector of the player.

When the system is connected using the **6CH. OUTPUT** jacks of the player, also select "SOUND" to set the speakers, audio output during DVD or VCD search, dynamic range control function and audio filters. (DV-5900M only)

Operation procedure

1. While the player is in stop mode, press the **SET UP** button and press the cursor up, down button to display the "SOUND" menu of "SET UP MENU".
2. Press the **ENTER** button to open the setup screen.

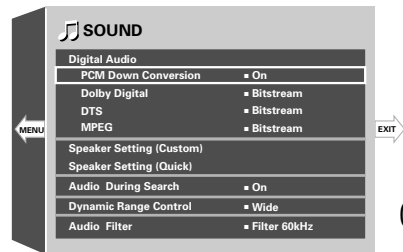

(DV-5900M)

3. In the setup menu, select the Function Item (refer to Right Table) by pressing the cursor up or down button and press the **ENTER** button.
4. Select the Setting Item (refer to Right Table) by pressing the cursor up or down button, then press the **ENTER** button to enter the selection in memory.

- "↶" : Select to return to the previous screen.

Table : SET UP MENU "SOUND" Function & Setting (1/2)

Function Item		Setting Item		Initial Position	
Icon	Function	Icon	Means	DV-5900M	Other
Digital Audio "PCM Down Conversion"	Switches on/off the down-sampling conversion for the digital signal output with a high sampling rate. ● With DVD AUDIO discs, the signal is always output after down sampling conversion.	On	Down-convert the signal to 44.1 kHz/16-bit PCM signal. The analog output signals are converted accordingly.	On	←
		Off	Skip down conversion. ● If the disc inhibits the 96 kHz digital output, the signal is down-converted even when this setting is selected.		
Digital Audio "Dolby Digital"	Sets the Dolby Digital output.	Bitstream	Bitstream signal.	Bitstream	←
		PCM	48 kHz (2CH.) PCM signal.		
Digital Audio "DTS"	Sets the DTS output.	DV-5900M		Bitstream	
		Bitstream	Bitstream signal.		
		PCM	48 kHz (2CH.) PCM signal.		
		Other		Off	
Bitstream	Bitstream signal.				
Off	off				
Digital Audio "MPEG"	Sets the MPEG output.	Bitstream	Bitstream signal.	Bitstream	←
		PCM	48 kHz (2CH.) PCM signal.		
Speaker Setting (Custom) (DV-5900M only)	→ 78				
Speaker Setting (Quick) (DV-5900M only)	→ 80				

Operation procedure

1. While the player is in stop mode, press the **SET UP** button and press the cursor up, down button to display the "**SOUND**" menu of "**SET UP MENU**".
2. Press the **ENTER** button to open the setup screen.

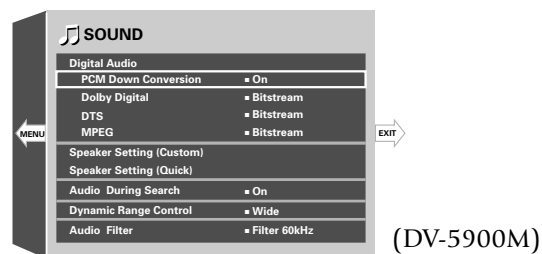

3. In the setup menu, select the Function Item (refer to Right Table) by pressing the cursor up or down button and press the **ENTER** button.
4. Select the Setting Item (refer to Right Table) by pressing the cursor up or down button, then press the **ENTER** button to enter the selection in memory.

- "↶" : Select to return to the previous screen.

Table : SET UP MENU "SOUND" Function & Setting (2/2)

Function Item		Setting Item		Initial Position	
Icon	Function	Icon	Means	DV-5900M	Other
Audio During Search	Switches on/off the audio during search. ● Audio is output only in the first speed step of fast forward.	On Off		On	←
Dynamic Range Control	Switches the dynamic range control function. This function compress the difference between max. and min. volume, and makes it easier to listen dialogue at low volume. This function only works with Dolby Digital DVD.	Wide	This function is OFF. Set plays the audio at the level recorded in the disc.	Normal	←
		Normal	This function works with Low compression ratio.		
		Midnight	This function works with High compression ratio.		
Audio Filter (DV-5900M only)	Protection for the connected speakers.	Filter 60 kHz	Select this position when the speakers are not suitable for high frequency response.	Filter 60 kHz	-
		Filter 110 kHz	Select this position when the speakers are suitable for high frequency response.		

7-4-2 "Speaker Setting" (DV-5900M only)

This unit has two kinds of speaker setting methods.

"Speaker Setting Custom" → 78

This is the normal setting operation.

"Speaker Setting Quick" → 80

This is the simplified setting operation.

a : Speaker Setting Custom

At the factory, the player has been set to the standard setting with which the speakers can reproduce the 6-channel signals as soon as the connections are made. This setting can be changed according to each listening environment. When you want to change this setting, be sure to perform it in the listening area in your own listening environment.

Operation procedure

1. While the player is in stop mode, press the **SET UP** button and press the cursor up, down button to display the "SOUND" menu of "SET UP MENU".
2. Press the **ENTER** button to open the setup screen.
3. Press the cursor up, down button to select "Speaker Setting (Custom)" in set up menu "SOUND", then press the **ENTER** button.

Table : "Speaker Setting CUSTOM" Function & Setting (1/2)

Speaker Item		Function Item		Setting Item		Initial Position
Icon	Speaker	Icon	Function	Icon	Means	
L R	L ch front speaker	Size	Low cut filter	Normal	Select this position when speaker is incapable of reproduce audio below 100 Hz.	Large
	Large			Select this position when speaker is capable of reproduce audio below 100 Hz.		
	Level	Set the volume level	0 to -12 dB	--	0 dB	
C	Center speaker	Size	Center channel output ON/OFF Low cut filter	Off	No center channel output. Select when Center speaker is not used.	Large
				Normal	Select this position when speaker is incapable of reproduce audio below 100 Hz.	
				Large	Select this position when speaker is capable of reproduce audio below 100 Hz.	
		Delay Time	Set delay time See "Delay Time Setting" → 81	0/1.3/2.6/ 3.9/5.3	--	0 ms
Level	Set the volume level	0 to -12 dB	--	0 dB		
SL SR	L ch surround speaker	Size	Surround channel output ON/OFF Low cut filter	Off	No surround channel output. Select when Surround speaker is not used.	Large
	R ch surround speaker			Normal	Select this position when speaker is incapable of reproduce audio below 100 Hz.	
				Large	Select this position when speaker is capable of reproduce audio below 100 Hz.	
	Delay Time	Set delay time See "Delay Time Setting" → 81	0/5.3/10.6/ 15.9	--	0 ms	
Level	Set the volume level	0 to -12 dB	--	0 dB		

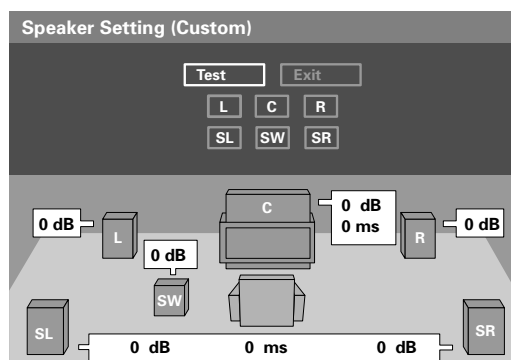

Table : "Speaker Setting CUSTOM" Function & Setting (2/2)

Speaker Item		Function Item		Setting Item		Initial Position
Icon	Speaker	Icon	Function	Icon	Means	
SW	Subwoofer	Size	Subwoofer channel output ON/OFF	Off	Select when Subwoofer is not used.	On
				On	Select when Subwoofer is used.	
		Level	Set the volume level	0 to -12 dB	--	0 dB

4. Select the Speaker item (refer to the table on the right) and press the **ENTER** button.
5. Select the Function item (refer to the table on the right) and press the **ENTER** button.
6. Select the Setting item (refer to the table on the right) and press the **ENTER** button.
7. Repeat steps 4 to 6 as required.
8. Press the cursor button to select "**Exit**", then press the **ENTER** button.

- For the "Speaker Setting" when an AV amplifier is connected digitally to the player, refer to the instruction manual of the AV amplifier.
- Note on the Speaker Level adjustment.

When a set of speaker(s) is installed, it is recommended to adjust the level using the Test Tone.

Speaker level setting using Test Tone

Operation procedure

1. Perform steps 1 and 3 of "Speaker Setting Custom".
→ 
2. Press the cursor button to select the "Test" button.
 - The Test Tone will be output from each speaker for a specified period of time, in the sequence beginning with the L CH speaker and ending with the Surround R CH speaker.
 - The speaker from which the Test Tone is being output is indicated by the cursor on the screen.
3. When the cursor moves to the speaker to be set, press the **ENTER** button.
4. Press the cursor left, right button to select the level to be set, and press the **ENTER** button.
 - Adjust so that the volume from all speakers is identical.
5. Press the cursor button to select "Exit", then press the **ENTER** button.

b : "Speaker Setting Quick" (DV-5900M only)

- For the "Speaker Setting" when an AV amplifier is connected digitally to the player, refer to the instruction manual of the AV amplifier.
- Three kinds of speakers can be set, including the "Center Speaker (C)", "Surround Speakers (SL/SR)" and "SubWoofer (SW)".

Operation procedure

1. While the player is in stop mode, press the **SET UP** button and press the cursor up, down button to display the "SOUND" menu of "SET UP MENU".
2. Press the **ENTER** button to open the setup screen.
3. Press the cursor up, down button to select "Speaker Setting (Quick)" in set up menu "SOUND", then press the **ENTER** button.

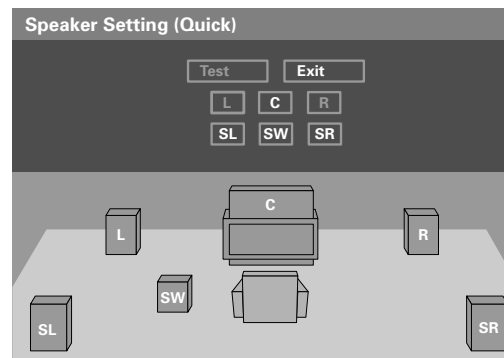

4. Place the cursor on the speaker name you want to set to "Use" or "Do not use", then press the **ENTER** button.

5. Each press of the **ENTER** button turns on and off the corresponding speaker icon in the graphic room at the lower half of screen alternately. When the selected kind of speaker is to be used, the corresponding speaker icon should be displayed.
6. To set the use of other kinds of speakers, repeat step 4 for each of them.
7. After completing the setting, place the cursor on "Exit" and press the **ENTER** button.

7-4-3 Delay Time Setting

When playing a DVD recorded with Dolby Digital audio, the distances from the listening position to the center and surround speakers should ideally be identical to those of all other speakers except for the subwoofer. The delay time setting makes it possible to compensate for the difference in distances of actual speakers by delaying the audio output from the center speaker and surround speakers so that the sounds from all speakers reach the listening position at the same timing. (The delay time adjustment is available only with Dolby Digital.)

Before starting the speaker setting, see the following figure and measure distance A of the center speaker ($A = D_f - D_c$) and distance B for the surround speakers ($B = D_f - D_s$). The standard delay time settings can be identified based on these values and the following tables.

Ideal center speaker position

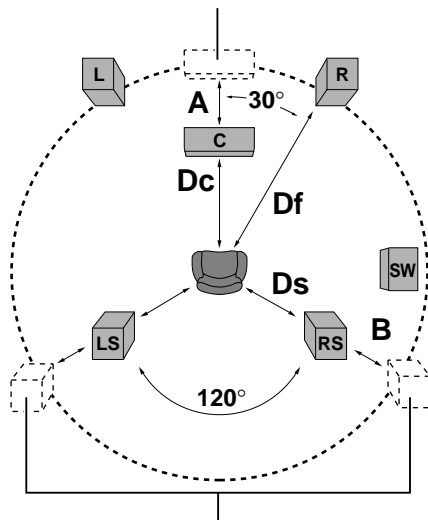

Ideal surround speaker positions

- All speakers should be laid out within a circle as shown in the figure.

Delay time of center speaker

Distance A ($A = D_f - D_c$)	Setting Value
Approx. 50 cm	"1.3" ms
Approx. 100 cm	"2.6" ms
Approx. 150 cm	"3.9" ms
Approx. 200 cm	"5.3" ms

- If distance D_f is equal to or shorter than D_c , set to "0".

Delay time of surround speakers

Distance B ($B = D_f - D_s$)	Setting Value
Approx. 200 cm	"5.3" ms
Approx. 400 cm	"10.6" ms
Approx. 600 cm	"15.9" ms

- If distance D_f is equal to or shorter than D_s , set to "0".

7-5 "VISUAL" Setting

7-5-1 When "VISUAL" is selected in "SET UP MENU":

Select "VISUAL" when you want to change the language used to display the menu screens, language use in menus on the disc, audio language, subtitle language, etc.

Also select "VISUAL" to set the still mode, FL mode, video format conversion system or TV SCART connector output signals.

Operation procedure

1. While the player is in stop mode, press the **SET UP** button and press the cursor up, down button to display the "VISUAL" menu of "SET UP MENU".
2. Press the **ENTER** button to open the setup screen.

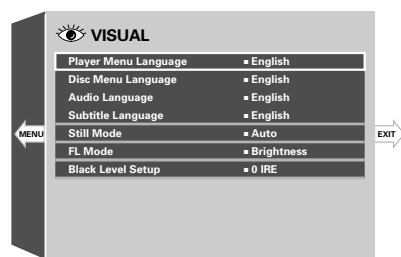

(DV-5900M)

- The "NTSC → PAL", "SCART Output Select" and "Black Level Setup" settings are not displayed in certain countries and areas.
3. In the setup menu, select the Function Item (refer to Right Table) by pressing the cursor up or down button and press the **ENTER** button.
 4. Select the Setting Item (refer to Right Table) by pressing the cursor up or down button, then press the **ENTER** button to enter the selection in memory.
- "↶" : Select to return to the previous screen.

Table : SET UP MENU "VISUAL" Function & Setting (1/3)

Function Item		Setting Item		Initial position	
Icon	Function	Icon	Means	DV-5900M	Other
Player Menu Language	Sets the language used to display the menu screens of the player.	English	English.	English	←
		French	French.		
		Spanish	Spanish.		
		German	German.		
		Italian"	Italian.		
		Japanese	Japanese.		
		Chinese	Chinese		
Disc Menu Language	Sets the language used to display the menu screens of the disc.	English	English.	English	←
		French	French.		
		Spanish	Spanish.		
		German	German. (U.K. and Europe only)		
		Italian	Italian. (U.K. and Europe only)		
		Other	Select to specify the language using a code No. listed in the " Disc Language Code Table ". → 85		
		Audio Language	Sets the language of the disc audio.		
English	English.				
French	French.				
Spanish	Spanish.				
German	German. (U.K. and Europe only)				
Italian	Italian. (U.K. and Europe only)				
Other	Select to specify the language using a code No. listed in the " Disc Language Code Table ". → 85				

Table : SET UP MENU "VISUAL" Function & Setting (2/3)

Operation procedure

1. While the player is in stop mode, press the **SET UP** button and press the cursor up, down button to display the "**VISUAL**" menu of "**SET UP MENU**".
2. Press the **ENTER** button to open the setup screen.

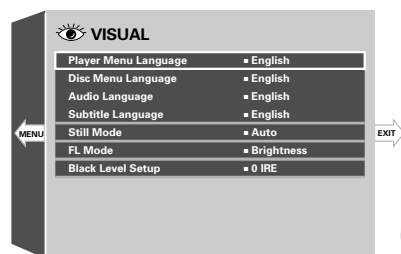

(DV-5900M)

- The "NTSC → PAL", "SCART Output Select" and "Black Level Setup" settings are not displayed in certain countries and areas.
3. In the setup menu, select the Function Item (refer to Right Table) by pressing the cursor up or down button and press the **ENTER** button.
 4. Select the Setting Item (refer to Right Table) by pressing the cursor up or down button, then press the **ENTER** button to enter the selection in memory.
- "↶" : Select to return to the previous screen.

Function Item		Setting Item		Initial Position	
Icon	Function	Icon	Means	DV-5900M	Other
Subtitle Language	Sets the language of the disc subtitles.	Auto	The subtitle language is selected automatically according to the "Audio language" setting.	English	←
		English	English.		
		French	French.		
		Spanish	Spanish.		
		German	German. (U.K. and Europe only)		
		Italian	Italian. (U.K. and Europe only)		
Other	Select to specify the language using a code No. listed in the " Disc Language Code Table ". → 85				
Still Mode	Reduces blur in still images.	Auto	Frame still and field still pictures are switched automatically. Usually select this setting.	Auto	←
		Frame	Frame still picture. Select this position when small text or patterns cannot be seen clearly at "AUTO" position.		
		Field	Field still picture. Select this position when jittering occurs in the still picture at "AUTO" position.		
FL Mode	Sets the brightness of the FL display. (on the player front panel.) ("FL OFF" cannot be selected with the "FL Mode" setting)	Brightness	The display is permanently in high brightness.	Brightness	←
		Dimmer	The display is permanently displayed in low brightness.		
		Auto Off	With a disc containing video, such as DVD or VCD During playback : Goes off During stop: "Brightness" status Other operation than playback: "Brightness" status for 3 seconds. With a disc without video, such as CD or MP3 The display remains in the "Brightness" status.		

Operation procedure

1. While the player is in stop mode, press the **SET UP** button and press the cursor up, down button to display the "**VISUAL**" menu of "**SET UP MENU**".
2. Press the **ENTER** button to open the setup screen.

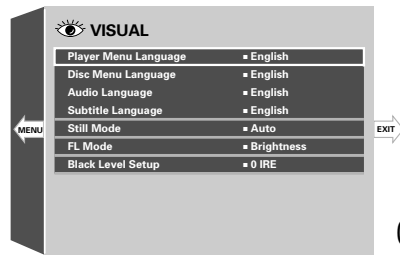

(DV-5900M)

- The "**NTSC → PAL**", "**SCART Output Select**" and "**Black Level Setup**" settings are not displayed in certain countries and areas.
3. In the setup menu, select the Function Item (refer to Right Table) by pressing the cursor up or down button and press the **ENTER** button.
 4. Select the Setting Item (refer to Right Table) by pressing the cursor up or down button, then press the **ENTER** button to enter the selection in memory.

- "↶" : Select to return to the previous screen.

Table : SET UP MENU "VISUAL" Function & Setting (3/3)

Function Item		Setting Item		Initial Position	
Icon	Function	Icon	Means	DV-5900M	Other
NTSC → PAL DVF-J6050	Switches if the signal from an NTSC format disc is to be converted into PAL or not.	On	Select to enable conversion from NTSC to PAL.	-	Europe and U.K. → On
		Off	Select to disable conversion from NTSC to PAL.		Except for Europe and U.K. → Off
SCART Output Select (U.K. and Europe only)	Switches the output signals from the TV SCART connector.	Composite	Composite video signal.	-	Composite
		S	S Video signals.		
		RGB	RGB signals.		
Black Level Setup DV-5900M DV-5050M	This function makes the adjustment of the black level. Set to your preference and monitor's ability.	7.5 IRE	Standard black level.	7.5 IRE	-
		0 IRE	Expanded black level.		

7-5-2 Disc Language Code Table

Cord No. : Language
6565 : Afar
6566 : Abkhazian
6570 : Afrikaans
6577 : Amharic
6582 : Arabic
6583 : Assamese
6588 : Aymara
6590 : Azerbaijani
6665 : Bashkir
6669 : Byelorussian
6671 : Bulgarian
6672 : Bihari
6678 : Bengali; Bangla
6679 : Tibetan
6682 : Breton
6765 : Catalan
6779 : Corsican
6783 : Czech
6789 : Welsh
6865 : Danish
6869 : German
6890 : Bhutani
6976 : Greek
6978 : English
6979 : Esperanto
6983 : Spanish
6984 : Estonian
6985 : Basque
7065 : Persian
7073 : Finnish
7074 : Fiji
7079 : Faroese
7082 : French

Cord No. : Language
7089 : Frisian
7165 : Irish
7168 : Scots Gaelic
7176 : Galician
7178 : Guarani
7185 : Gujarati
7265 : Hausa
7273 : Hindi
7282 : Croatian
7285 : Hungarian
7289 : Armenian
7365 : Interlingua
7378 : Indonesian
7383 : Icelandic
7384 : Italian
7387 : Hebrew
7465 : Japanese
7473 : Yiddish
7487 : Javanese
7565 : Georgian
7575 : Kazakh
7576 : Greenlandic
7577 : Cambodian
7578 : Kannada
7579 : Korean
7583 : Kashmiri
7585 : Kurdish
7589 : Kirghiz
7665 : Latin
7678 : Lingala
7679 : Laothian
7684 : Lithuanian
7686 : Latvian; Lettish

Cord No. : Language
7771 : Malagasy
7773 : Maori
7775 : Macedonian
7776 : Malayalam
7778 : Mongolian
7779 : Moldavian
7782 : Marathi
7783 : Malay
7784 : Maltese
7789 : Burmese
7865 : Nauru
7869 : Nepali
7876 : Dutch
7879 : Nowegian
7982 : Oriya
8065 : Punjabi
8076 : Polish
8083 : Pashto; Pushto
8084 : Portuguese
8185 : Quechua
8277 : Rhaeto-Romance
8279 : Romanian
8285 : Russian
8365 : Sanskrit
8368 : Sindhi
8372 : Serbo-Croatian
8373 : Singhalese
8375 : Slovak
8376 : Slovenian
8377 : Samoan
8378 : Shona
8379 : Somali
8381 : Albanian

Cord No. : Language
8382 : Serbian
8385 : Sundanese
8386 : Swedish
8387 : Swahili
8465 : Tamil
8469 : Telugu
8471 : Tajik
8472 : Thai
8473 : Tigrinya
8475 : Turkmen
8476 : Tagalog
8479 : Tonga
8482 : Turkish
8484 : Tatar
8487 : Twi
8575 : Ukrainian
8582 : Urdu
8590 : Uzbek
8673 : Vietnamese
8679 : Volapük
8779 : Wolof
8872 : Xhosa
8979 : Yoruda
9072 : Chinese
9085 : Zulu

Chapter 8 : Other Information

This chapter is composed of the following sections.

Malfunction of Microcomputer	→ 86
To Be Noted	→ 87
Troubleshooting	→ 89
Glossary	→ 91
Specifications	→ 95

8-1 Malfunction of Microcomputer

In case the microcomputer malfunctions, making operations impossible or showing wrong messages on the display even if you connected everything properly. When the microcomputer malfunctions, perform the following procedure to reset the microcomputer and return it to the normal condition.

Operation procedure (Main unit)

1. While holding the **USER FILE** button on the main unit, press the **POWER** button.
 - The display on the main unit shows "**INITIALIZE OK**" (initializing).
2. Press the **POWER** button on the main unit to turn it off.
3. Press the **POWER** button again.
("STANDBY" indicator lights)
4. Press the ► button on the main unit.
 - The resetting clears the setups stored in the microcomputer and returns it to the factory-set initial condition. After resetting, you should perform the various setups of the player again from the beginning.

8-2 To Be Noted

Maintenance of the unit

When the front panel or case becomes dirty, wipe with a soft, dry cloth. Do not use thinner, benzine, alcohol, etc. for these agents may cause discoloration.

In regard to contact cleaner

Do not use contact cleaners because it could cause a malfunction. Be specially careful not to use contact cleaners containing oil, for they may deform the plastic component.

Never play a cracked or warped disc

During playback, the disc rotates at high speed in the player. Therefore, to avoid danger, never use a cracked or deformed disc or a disc repaired with tape or adhesive agent. Please do not use discs which are not round because they may cause malfunction.

Disc accessories

The disc accessories (stabilizer, protection sheet, protection ring, etc.) which are marketed for improving the sound quality or protecting discs as well as the disc cleaner should not be used with this system because they may cause malfunction.

Discs which can be played with this unit

DVD (12 cm), CD (12 cm), VCD, and the audio part of CDV, CD-G, CD-EG and CD-EXTRA. Use discs that comply with the IEC standard, for example a disc carrying

the  marking on the label surface.

Disc handling precautions

Handling : Hold the disc so that you do not touch the playing surface.

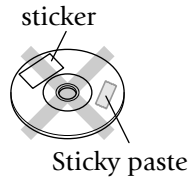

Do not attach paper or tape to either the playing side or the label side of the discs.

Cleaning : If there are fingerprint marks or foreign matter found on the disc, lightly wipe the disc with a soft cotton cloth (or similar) from the center of the disc outwards in a radial manner.

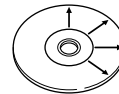

Storage : When a disc is not to be played for a long period of time, remove it from the player and store it in its case.

Caution on condensation

Condensation (of dew) may occur inside the unit when there is a great difference in temperature between this unit and the outside.

This unit may not function properly if condensation occurs. In this case, leave the unit for a few hours and restart the operation after the condensation has dried up.

Be specially cautious against condensation in the following circumstances:

When this unit is carried from one place to another across a large difference in temperature, when the humidity in the room where this unit is installed increases, etc.

Transport or moving precautions

When transporting or moving the player, first remove the disc and observe the following procedure.

1. Turn the player power on.
2. If any disc is left in the player, eject all of the discs left in it.
3. Wait for a few seconds, until the display shows "**NO DISC**".
4. Turn the player power off by pressing the **POWER** button.

Apparatus Claims of U.S. Patent Nos. 4,631,603, 4,577,216, 4,819,098, and 4,907,093 licensed for limited viewing uses only.

This product incorporates copyright protection technology that is protected by method claims of certain U.S. patents and other intellectual property rights owned by Macrovision Corporation and other rights owners. Use of this copyright protection technology must be authorized by Macrovision Corporation, and is intended for home and other limited viewing uses only unless otherwise authorized by Macrovision Corporation. Reverse engineering or disassembly is prohibited.

Consumers should note that not all high definition television sets are fully compatible with this product and may cause artifacts to be displayed in the picture. In case of 525 progressive scan picture problems, it is recommended that the user switch the connection to the "STANDARD DEFINITION" output. If there are questions regarding our TV set compatibility with this model 525p DVD player, please contact our customer service center.

For DV-5900M

Manufactured under license from Digital Theater Systems, Inc. US Pat. No. 5,451,942, 5,956,674, 5,974,380, 5,978,762 and other worldwide patents issues and pending. "DTS" and "DTS Digital Surround" are registered trademarks of Digital Theater Systems, Inc. © 1996, 2000 Digital Theater Systems, Inc. All rights reserved.



For DV-5050M/DVF-J6050

"DTS" and "DTS Digital Out" are trademarks of Digital Theater Systems, Inc.



Manufactured under license from Dolby Laboratories. "DOLBY" and the double-D symbol are trademarks of Dolby Laboratories.

CAUTION (For the U.S.A.)

Use of controls or adjustments or performance of procedures other than those specified herein may result in hazardous radiation exposure.

In compliance with Federal Regulations, following are reproductions of labels on, or inside the product relating to laser product safety.

KENWOOD CORPORATION
2967-3, ISHIKAWA-CHO,
HACHIOJI-SHI,
TOKYO, JAPAN

**KENWOOD CORP. CERTIFIES THIS
EQUIPMENT CONFORMS TO DHHS
REGULATIONS NO. 21 CFR
1040.10, CHAPTER 1, SUBCHAPTER J.**

Location: Back Panel

FCC WARNING (For the U.S.A.)

This equipment may generate or use radio frequency energy. Changes or modifications to this equipment may cause harmful interference unless the modifications are expressly approved in the instruction manual. The user could lose the authority to operate this equipment if an unauthorized change or modification is made.

NOTE :

This equipment has been tested and found to comply with the limits for a Class B digital device, pursuant to Part 15 of the FCC Rules. These limits are designed to provide reasonable protection against harmful interference in a residential installation. This equipment may cause harmful interference to radio communications, if it is not installed and used in accordance with the instructions. However, there is no guarantee that interference will not occur in a particular installation. If this equipment does cause harmful interference to radio or television reception, which can be determined by turning the equipment off and on, the user is encouraged to try to correct the interference by one or more of the following measures:

- Reorient or relocate the receiving antenna.
- Increase the separation between the equipment and receiver.
- Connect the equipment into an outlet on a circuit different from that to which the receiver is connected.
- Consult the dealer or an experienced radio / TV technician for help.

8-3 Troubleshooting

Playback starts but the video is not output.

- The Pure Audio function is set to on. → [36](#)
- The input selection of the TV and/or AV amplifier is incorrect or these devices are not turned on.
- Connection cords are connected improperly.

Playback starts but the audio is not output.

- The "Speaker Setting" is incorrect.
- The input selection of the TV and/or AV amplifier is incorrect or these devices are not turned on.
- The volume of the TV and/or AV amplifier is not adjusted properly.
- Audio output cords are connected improperly.

The picture is disturbed during forward search or reverse search.

- The picture disturbance during forward search or reverse is normal. This is not a malfunction.

The picture is not neat or the video or audio quality is poor.

- Connection cords are connected improperly.
- A device generating noise is installed near the signal path.
- The disc is dirty or damaged. To prevent this, remove dirt and handle discs carefully so as not to damage them.
- There may be condensation of dew on the optical lenses. In this case, leave the player with power ON for a few hours to dry up the condensation, then retry operation.

It takes long time before playback starts.

- The disc type should be detected and motor rotation stabilized before starting playback. This is normal and not a malfunction.

A warning is displayed on the TV screen and playback is not possible.

- The reproduced video may be disturbed or audio may be skipped when the disc surface is stained with fingerprints or dirt. Clean the disc surface by wiping it in the radial directions using a soft cloth.
- If the disc is placed obliquely or on another disc, place the disc correctly. → [29](#)
- Playback may be unavailable due to viewing restriction or region code problem.

The top and bottom edges of the picture are cut off.

- The video format of the played disc does not match that of the connected TV.

VCD cannot be played with menu playback.

- Menu playback is not available when P.B.C. is Off or the sequential play mode of the player is set to "Sequential On". → [34](#)
- Menu playback is possible only with P.B.C.-compatible VCDs. → [33](#)

DVD VIDEO cannot be played.

- DVD VIDEO cannot be played when the sequential mode of the player is set to "Sequential On". Switch it to "Sequential Off". → [34](#)

Subtitles are not displayed.

- Subtitles are not displayed when the played DVD does not contain the recording of subtitles.
- The subtitle language is set to "Off". → [45](#)

Audio (or subtitle) language cannot be changed.

- The language cannot be switched when the played DVD does not contain the recording of multiple audio (or subtitle) languages. → [43](#) → [45](#)

Viewing angle cannot be changed.

- The viewing angle cannot be switched when the played DVD does not contain the recording of multiple angles. The viewing angle can neither be switched in part where no angle is recorded. → [47](#)

The viewing restriction (Rating) cannot be changed.

- If you have lost the password, initialize to the factory setting.

Initializing.

→ [86](#)

The selected audio or subtitle languages is not played.

- If the played DVD does not contain the default language set by the user, the priority language specified for the disc will be selected. → [43](#) → [45](#)

The TV screen does not show any message when a button is pressed.

- If "On Screen Message" is set to "Off", switch it "On". → [74](#)

The messages in the menus are not displayed in the

selected language.

- If the played DVD does not contain the recording of the default language set by the user, the priority language specified for the disc will be selected.

→ 82

Remote control with the standard remote is impossible.

- The batteries are exhausted.
- The controller position is too apart from the remote sensor, the control angle is deviated or there is an obstacle between the remote and remote sensor.

→ 12

An inhibition icon is displayed and no operation is accepted.

- The operations of certain DVDs and VCDs are restricted by the intention of the software producers. Such discs should be operated in accordance with the software. Operations may also be restricted depending on the player status.

DVD playback cannot be stopped by pressing the STOP button.

- With certain DVDs, the inhibition icon is displayed and playback cannot be stopped even when the ■ button is pressed. In this case, press the **DISC + (up)**, **- (down)** button to select another disc then press the ■ button to stop playback.

If there is only one disc in the carousel, open the disc door, place another disc, close the disc door, press the **DISC + (up)**, **- (down)** button to select the second disc, then press the ■ button to stop playback.

The player display shows nothing.

- The player display is set to "**FL OFF**". → 23

The display shows "LOCKED" and no operation is accepted.

- Initializing → 86

The COMPONENT VIDEO OUTPUT jacks of the player do not output video signals.

- When "**RGB**" is set in the "**SCART Output Select**" setting, the **COMPONENT VIDEO OUTPUT** terminals of the player do not output video signals.

A MP3 disc cannot be played back.

- Certain MP3 discs are unplayable on this player.

An erroneous character is displayed in the title display.

- The displayed characters may become erroneous if the disc has been created on a PC, etc.

8-4 Glossary

DVD (Digital Versatile Disc) : DVD VIDEO is a disc featuring high video/audio quality, made possible by large recording capacity of video and audio signals of movie software, etc. and by digital signal processing. DVD AUDIO has been desired to provide even higher audio quality than DVD VIDEO by using high-bit, high sampling rate processing.

VIDEO CD (VCD) : This is a CD containing moving picture. By compressing video data to about 1/120 and audio data to about 1/6, a 12 cm disc with the same size as ordinary music CD can store moving pictures and audio for up to about 74 minutes.

The VCD includes the P.B.C.-incompatible discs with only the playback capability (Version 1.1) and P.B.C.-compatible discs with the menu playback and special playback capabilities (Version 2.0)

MPEG (Moving Picture Expert Group) (DVD, VCD) : A digital video and audio compression and decompression system which is standardized as an international standard.

Decoder : A device for restoring standard audio signal from audio data recorded based on coding into DVD data, etc. This processing is referred to as decoding.

Downmixing : Conversion of multichannel audio signals of DVD or DTS-CD into 2-channel stereo signals.

Sampling rate : Sampling refers to converting an analog signal into digital signal by slicing the analog signal into fine parts at a certain time interval and digitizing every sliced part. The sampling rate is the count of slicing per second. The original sound can be reproduced more faithfully when the sampling rate is higher.

Quantization bit : The quantization bit count refers to the number used in digitizing the sliced parts obtained by slicing the analog signal as described above. The quantization bit count is the number of bits used in digitization per second. The original sound can be reproduced more faithfully when the quantization bit count is larger.

Linear PCM (Pulse Code Modulation): Audio signal format without using compression. In the DVD which has a very large disc capacity, the linear PCM signal using high sampling rate can be recorded.

Packed PCM : The packed PCM (P.PCM) signal is obtained by compressing the linear PCM signal featuring large data amount and high sampling rate. With this compression, the signal before compression can be restored perfectly.

Bitstream (DVD) : This is the generic name given for the flow of data based on a standard such as Dolby Digital, DTS, MPEG, etc.

Dolby Digital : A digital audio compression technology developed by Dolby Laboratories, Inc. It is compatible with 5.1-channel surround audio as well as 2-channel stereo, and capable of recording a large amount of audio data efficiently in a disc.

DTS : Digital surround system developed by Digital Theater Systems, Inc.

Title/Title No. (DVD VIDEO) : The title is the largest unit of video or audio recorded in DVD VIDEO. Usually, a title corresponding to a movie product with video software or an album (or a piece of music) with music software. The numbers assigned to the titles are referred to as title numbers.

Chapter/Chapter No. (DVD VIDEO) : The chapter is a partition of video or audio that is smaller than the title. A title is composed of multiple chapters. The numbers assigned to the chapters are referred to as chapter numbers.

Group/Group No. (DVD AUDIO) : The group is the largest unit of the contents in DVD AUDIO. Usually, a group corresponds to an album. The numbers assigned to the groups are referred to as group numbers.

Track/Track No. (DVD AUDIO, VCD, CD) : The track is a partition of audio (such as a piece of music or music chapter) in a disc. These partitions are numbered and the numbers are referred to as track numbers. While a track usually corresponds to a piece of music with DVD AUDIO or ordinary music CD, the partitions of contents and track numbers are not always corresponding with VCD. As a result, while all of the playback operations including track skipping and programming of ordinary music CD are based on the track number information, such operations may sometimes be unavailable with VCD.

AVTT (Audio Video Title): Part of DVD AUDIO that contains moving pictures. The audio language, subtitle language and viewing angles in this part can be switched by the user.

AOTT (Audio Only Title): Part of DVD AUDIO that contains audio and still pictures. The audio language and still pictures in this part can be switched by the user.

Subtitle language (DVD): Some DVDs contain the recording of multiple subtitle languages. This player allows the user to select desired one of the recorded subtitle languages during playback of such a DVD.

Angle (DVD): Some DVDs contain the recording of multiple viewing angles. This player allows the user to select desired one of the recorded angles during playback of such a DVD.

Audio language (DVD): Some DVDs contain the recording of multiple audio languages. This player allows the user to select desired one of the recorded audio languages during playback of such a DVD.

Aspect ratio : The ratio between the horizontal and vertical sizes of picture displayed on a TV screen. The aspect ratio of ordinary TV is 4:3, and that of widescreen TV is 16:9.

Pan & scan (DVD) : Method of displaying a horizontally-long picture recorded in 16:9 aspect ratio on a 4:3 TV screen by trimming part of picture. In general, the trimming positions for pan & scan are determined uniformly by the reproducing device. However, the pan & scan of DVD allows the software producer to specify the trimming positions to be used in playback.

Letterbox (DVD) : Method of displaying a horizontally-long picture recorded in 16:9 aspect ratio on a 4:3 TV screen by attaching bands at the top and bottom of the screen and displaying the horizontally-long picture at the center of screen.

Frame (DVD, VCD) : Each frame of a moving picture, that is displayed 30 times a second with NTSC and 25 times a second with PAL. These TV formats reproduce moving pictures by displaying still pictures sequentially.

Field (DVD, VCD) : Part of a frame obtained by dividing the video data of each frame by two. Each frame of ordinary TV is constitute by displaying the fields alternately.

Frame still/Field still (DVD, VCD) : Types of still pictures obtained by temporarily stopping a moving picture. The frame still picture may produce blur in the picture because it displays two specific fields alternately, but the picture quality is higher. The field still picture has lower picture quality because it uses half the picture information of frame still, but is not accompanies with picture blur.

IPB display (DVD) : With the MPEG2 which is one of the video display methods of DVD, each picture is divided into the following three picture types before being coded in digital signal.

I-picture (Intra coded) : This is the standard video and can constitute a picture by itself. As the highest picture quality can be obtained, the still image of I-picture is most suitable for use when adjusting the picture quality.

P-picture (Predictive coded) : Picture calculated based on past pictures (I-picture or B-picture).

B-picture (Bidirectionally predictive coded) : Picture calculated by comparing the previous and next pictures (I-pictures or P-pictures). This picture type contains least amount of video information.

P.B.C. (PlayBack Control) (VCD) : VIDEO CDs carrying messages such as "Playback Control Capable" can be played interactively by selecting the desired play position or information in hierarchical structures while watching the menus displayed on the TV screen.

OSD (On-Screen Display) : OSD is a method of interactive operations using the menus and icons displayed on the TV screen.

On-Screen Message : Message displayed on the TV screen when an operation is performed.

Downconversion : Conversion of PCM signal with high sampling rate such as 96 kHz and 192 kHz into a signal with a sampling rate of 48 kHz or 44.1 kHz.

Dynamic range : Difference between the minimum reproducible audio signal and maximum reproducible audio signal.

Progressive scanning : This is a TV screen scanning method, which scans a screen in order of scanning lines from the first scanning line.

It can reduce image flickering in still images containing characters, graphics and horizontal lines.

Interlace scanning : This is a TV screen scanning method, which scans a screen by dividing it into two fields. It begins scanning with the odd number scanning lines then proceed to the scanning of even number scanning lines to display a single image by making use of the persistence of residual image.

This method is applied in the previous TV formats.

Multi Session : With CD recording, a session refers to an area composed of three recording areas including the lead-in area (which indicates the location of data), data area and lead-out (which indicates the end of session). A CD containing more than one session in a disc is referred to as a multi-session disc.

8-5 Specifications

[DV-5900M]

Format section

Format

..... DVD video ver. 1.1 / DVD audio ver.1.2

Laser Semiconductor laser

Audio section

Frequency response

Sampling frequency: 44.1kHz (CD only)

..... 4 Hz ~20 kHz

Sampling frequency: 96 kHz 4 Hz ~ 44 kHz

Sampling frequency: 192 kHz (DVD AUDIO only)

..... 4 Hz ~ 88 kHz

Signal to noise ratio More than 120 dB

Dynamic range More than 100 dB

Total harmonic distortion

..... Less than 0.003 % (1kHz)

Channel separation More than 95 dB (1kHz)

Analog output level/impedance

MIX LINE OUTPUT 2 V/ 510 Ω

6 CH OUTPUT 2 V / 510 Ω

Digital output level/impedance

COAXIAL 0.5 Vp-p/ 75 Ω

OPTICAL (Wave length 660 nm)

..... -21 dBm ~ -15 dBm

Video Section

Video output format NTSC

Composite video output level 1 Vp-p (75 Ω)

S-video output level

(Y-signal) 1 Vp-p (75 Ω)

(C-signal) 0.286 Vp-p (75 Ω)

Component video output level

(Interlace/ "Black Level Setup" =7.5 IRE)

(Y-signal) 1 Vp-p (75 Ω)

(CB-signal) 0.68 Vp-p (75 Ω)

(CR-signal) 0.68 Vp-p (75 Ω)

Video signal to noise ratio 65 dB

Horizontal resolution 500 lines

Laser Section

Wavelength

..... 643 ~ 683 nm (DVD play)

Laser power class class 2 (IEC)

General Section

Power consumption 40 W

Dimensions W : 440 mm (17-5/16")

H : 203 mm (8")

D : 555 mm (21-20/17")

Weight (net) 10.4 kg (22.9 lb)

KENWOOD follows a policy of continuous advancements in development. For this reason specifications may be changed without notice.

Sufficient performance may not be exhibited at extremely cold locations (Where water freezes).

[DV-5050M/DVF-J6050]**Format section**

Format DVD video ver. 1.1
Laser Semiconductor laser

Audio section**Frequency response**

Sampling frequency: 44.1kHz (CD only)
 4 Hz ~ 20 kHz
 Sampling frequency: 96 kHz 4 Hz ~ 44 kHz

Signal to noise ratio More than 115 dB

Dynamic range More than 92 dB

Total harmonic distortion

..... Less than 0.0045 % (1kHz)

Channel separation More than 92 dB (1kHz)

Analog output level/impedance

MIX LINE OUTPUT 2 V/ 510 Ω

Digital output level/impedance

COAXIAL 0.5 Vp-p/ 75 Ω
 OPTICAL (Wave length 660 nm)
 -21 dBm ~ -15 dBm

Video Section**Video output format**

DV-5050M NTSC

DVF-J6050

For Europe PAL/PAL60

For Asia NTSC/PAL

For U.S. Military NTSC

Composite video output level 1 Vp-p (75 Ω)

S-video output level

(Y-signal) 1 Vp-p (75 Ω)

(C-signal) 0.286 Vp-p (75 Ω)

Component video output level**[DV-5050M]**

(Interlace/ "Black Level Setup" =7.5 IRE)

(Y-signal) 1 Vp-p (75 Ω)

(Cb-signal) 0.68 Vp-p (75 Ω)

(Cr-signal) 0.68 Vp-p (75 Ω)

[DVF-J6050 for Europe, U.S. Military and Asia]

(Y-signal) 1 Vp-p (75 Ω)

(Cb-signal) 0.7 Vp-p (75 Ω)

(Cr-signal) 0.7 Vp-p (75 Ω)

Video signal to noise ratio 60 dB

Horizontal resolution 500 lines

Laser Section**Wavelength**

..... 643 ~ 683 nm (DVD play)

Laser power class class 2 (IEC)

General Section**[DV-5050M]**

Power consumption 35 W

Dimensions W : 440 mm (17-5/16")

H : 203 mm (8")

D : 555 mm (21-20/17")

Weight (net) 10.4 kg (22.9 lb)

[DVF-J6050]

Power consumption 35 W

Dimensions W : 440 mm (17-5/16")

H : 203 mm (8")

D : 555 mm (21-20/17")

Weight (net) 10.4 kg (22.9 lb)

KENWOOD follows a policy of continuous advancements in development. For this reason specifications may be changed without notice.

Sufficient performance may not be exhibited at extremely cold locations (Where water freezes).

KENWOOD

For your records

Record the serial number, found on the back of the unit, in the spaces designated on the warranty card, and in the space provided below. Refer to the model and serial numbers whenever you call upon your dealer for information or service on this product.

Model _____ Serial Number _____